



Z-800 III
Stage Fog Machine
User Manual
- English
- 中文



1. Introduction	1
2. Safety Information.....	1
3. Package Contents & Inspection.....	2
4. Machine Details.....	3
5. Technical Label Information.....	3
6. Fog Liquid	3
7. Setting and Manual Operation.....	4
8. Control Settings	4
9. Z-10 Cable Remote (Standard).....	4
10. Z-40 Timer Cable Remote (Optional).....	5
11. Z-50 Wireless Remote (Optional).....	5
12. Service and Maintenance.....	6
13. Technical Specifications	6
14. Warranty Disclaimer.....	6
15. Machine Dimension.....	7
1. 前言	8
2. 安全注意事項	8
3. 包裝內容與檢查	9
4. 機器訊息	10
5. 技術標籤資訊	10
6. 煙霧油	10
7. 設定與手動操作說明	11
8. 控制設定	11
9. Z-10 有線控制器(標配).....	11
10. Z-40 有線定時控制器(選配).....	12
11. Z-50 無線控制器(選配).....	12
12. 維護和保養	12
13. 技術規格	13
14. 保固聲明	13
15. 機器尺寸圖	13
Appendix I Grounding Instruction	14





User Manual

1. Introduction

Please read all the user manual before operating the machine, and place the manual where the user can refer to it at all time. The manual includes how to install and operate the machine under safe condition and explain all the labels printed on the machine. If you encounter any problem, contact your local Antari dealer for assistant immediately.

2. Safety Information

 DANGER	If the danger is not avoided, it will cause death or series injury
 WARNING	If the warning is not heeded, it can cause death or serious injury.
 CAUTION	If the precaution is not taken, it may cause minor or moderate injury.



DANGER

- Must connect the machine to the correct rated voltage or it might lead to an electrical shock or a burn and may cause serious consequences.
- Must connect the machine to a protected circuit and ensure it is properly grounded to avoid the risk of electrocution. For grounding instruction, please refer to Appendix I on page 14.
- Do not operate the machine with a bundled power cord, it could lead to a fire hazard.
- When operating the machine, do not point at people, animals, or fire.



WARNING

- Machine's nozzle is extremely hot, please keep at least 50cm distance from the nozzle when the machine is running.
- Please operate the machine on a flat, level hard and well ventilated surface area, reserve at least 50 cm space around the machine and make sure there is no flammable gas or material nearby.
- Do not disassemble, repair or modify the machine, it may cause damages, malfunction, risk of electrical shock or result in fire.
- The machine can only be operated by adults or professionals, is not intended for use by person with reduced physical sensory, mental capabilities, or lack of experience and knowledge including children.
- Do not leave the machine running unattended, make sure all powers are off when leaving.
- Children should be supervised to ensure that they do not play with the machine.
- Do not use the machine upside down or tilt it, it might cause damages or malfunction.
- Please store the fluid inside in a well ventilated area without direct sunlight and keep out of reach of children. In case of eye contact or accidentally swallow the fluid, please seek medical attention immediately.



CAUTION

- Keep the machine dry at all time. The machine is not waterproof, do not expose the machine to water, rain, or

moisture environment.

- Please make sure the power outlet is not damaged or loose before plug in the power cord.
- If the power cord is damaged, it must be replaced by Antari or its local dealers, otherwise the warranty will be void.
- Before operating the machine, please sure the fluid is filled in the fluid tank to avoid the pump in idling state which could lead to overeat or malfunction.
- Before transporting the machine, please make sure the fluid is drained and tank is empty. (Recommend using original package)
- The machine is for indoor use only.
- Do not operate the machine in any area with unstable voltage.
- If you experience strange sound or malfunction, turn off the power and unplug the power cord immediately and contact your local Antari dealer for assistant.
- Do not contact any moving part.
- Only use accessories recommended or sold by Antari.
- Please make sure the power is off when not using the machine and unplug the power cord if not intend to use for a long period of time.
- To disconnect, turn all control to the off (“O”) position, then remove plug from outlet.
- Do not unplug by pulling on cord. To unplug, grasp the plug, not the cord.
- Unplug from outlet before servicing or cleaning.
- Do not operate the machine with a damaged cord or plug, or after the machine malfunctions or is dropped or damaged in any manner. Return machine to the nearest authorized service facility for examination, repair, or electrical or mechanical adjustment.
- To ensure the lifespan of the machine, please only use the fluid manufactured by Antari, do not use other fluid or additive, otherwise it may clog the heater and cause malfunction.

Before operating the machine, please read all warning labels on the machine, description as below:

Top Cover Printing

WARNING!

HOT NOZZLE!

KEEP AT LEAST 50 CM DISTANCE

Rear Cover Printing

WARNING!

DISCONNECT POWER BEFORE CHANGING FUSE

USE ONLY WITH ADULT SUPERVISION

DO NOT OPERATE WITHOUT LIQUID

FOR INDOOR USE ONLY. KEEP DRY

NO USER SERVICEABLE PARTS INSIDE

LIQUID

ONLY USE MANUFACTURER DESIGNATED FLUID

ATTENTION!

NEVER ADD FLAMMABLE SUBSTANCES

3. Package Contents & Inspection

Immediately upon receiving the machine, carefully unpack the carton, check the content to ensure it is the correct model and all parts are included. If any part appears to be damaged or missing during transportation, please contact your local dealer and return with original package for inspection.

3.1 Package Contents

1 x Z-800 III Fog Machine

1 x Power Cord

1 x Z-10 Cable Remote

1 x User Manual or scan QR code on the machine

3.2 Optional Accessories

Item Code	Description
Z-40	Cable Timer Remote
Z-50	Wireless Remote

4. Machine Details



01. Fog Nozzle	05. Power Switch
02. Button	06. Fuse
03. Handle	07. Power Input
04. Tank Cap	08. 6.5mm Cable Remote Port

5. Technical Label Information

Please read the technical label information on the back of the machine before operating it.

1. Model Name	5. Breaker
2. Input Voltage	6. QR CODE for User Manual
3. Frequency	7. Serial No.
4. Rated Power	

6. Fog Liquid

	CAUTION!	Always turn off the power before filling the fluid tank. Do not add flammable liquid to the fluid tank. If fluid gets inside the machine, please contact your local Antari dealer for assistant.
--	-----------------	--

- Only the fog liquid manufactured by Antari can be used, do not mix or dilute the fog liquid. Due to improper storage or using other fluid might clog the heater and cause malfunction.
- The machine is tested and calibrated with the specific fog liquid to get the best performance.
- Please empty the fluid in the tank before switching to another fluid to avoid mixing.
- Only the essence manufactured by Antari can be used, and add according to the ratio recommended by Antari

(Recommended ratio is 1:1000), if using other essence or different ratio might clog the heater and cause malfunction.

- The warranty on your fog machine will be void if you use fog liquid other than that recommended by the Antari of your smoke machine.

7. Setting and Manual Operation

 WARNING	Machine falling off might cause serious injury, please make sure it is secure and firm on the overhead.
--	---

- Step 1.** Place the machine on a flat, level hard and well ventilated surface area and reserve at least 50 cm open space around the machine, and make sure there is no flammable gas or material nearby;
- Step 2.** Fill the fluid tank with Antari approved fog liquid, and make sure the tube is not twisted;
- Step 3.** Plug the machine to the power outlet. Please read the technical label on the back of the machine and make sure the power outlet has the correct rated voltage for the machine;
- Step 4.** Turn on the power, the machine starts to warm up and the button on the handle will show red blinking light. The warming process takes approximately 2 minutes. Once the machine has reached its operating temperature, the red blinking light will turn solid. Now the machine is ready for operation;
- Step 5.** To start fogging, please press the button on the handle. To stop fogging, please release the button the handle;
- Step 6.** To turn off the power, please make sure the machine is not operating. If you will not use the machine a long period of time, please unplug the power cord.

**When install the machine overhead, please make sure all connecting and rigging hardware are fasten and secured. The overhead must be able to bear at least 10 times the weight of the machine.

8. Control Settings

Z-800 III Fog Machine can be operated in the following modes. The machine can only accept 1 type of signal at a time. When using different control modes at the same time, the machine will work according to built-in control priority:

- Cable Remote
- Timer Cable Remote
- Wireless Remote
- Manual

9. Z-10 Cable Remote (Standard)



Z-10 Cable Remote is a standard accessory for Z-800 III fog machine, please see instruction below;

1. Plug the cable remote to the back of the machine;
2. When the green indicator light is solid, it's ready to fog;
3. Press and hold the red button to start fogging and release the red button to stop fogging.

** If you encounter any problem, please contact your local Antari dealer for assistant.

12. Service and Maintenance

	DANGER!	Disconnect the power cord before starting maintenance operation!
---	----------------	--

- Always keep the machine clean.
- Can use an air compressor, a vacuum or a soft brush to remove the dust on the machine.
- Can use a slightly damp cloth to clean the casing.
- Before store the machine, please make sure the machine is completely cool down to avoid moisture inside the machine causing malfunction.
- It is recommended to run the machine at least once a month in order to maintain its best performance and output condition.
- Excessive dust and build up liquid residue will reduce the performance and cause overheat.

13. Technical Specifications

Z-800 III	
Input Voltage	US Model : AC 100-120V, 50/60Hz 6.7A EU Model : AC 220-240V, 50/60Hz 3.4A
Rated Power	800W
Warm-Up Time	2 minutes (approx.)
Fluid Consumption	13 ml/min (100% output)
Fluid Tank Capacity	0.8 Liters (0.21 gallon)
Compatible Fluid	Antari FLG Heavy Fog Fluid 、 Antari FLR Light Fog Fluid
Ambient Temp. Range	0°C – 40°C (32°F – 104°F)
Control Methods	Manual 、 Cable Remote 、 Timer 、 Wireless
Interface	N/A
DMX Channel	N/A
Optional Accessories	Z-40 Timer Cable Remote 、 Z-50 Wireless Remote
Dimension	L 315 W 128 H 218 mm (L 12.4 W 5.0 H 8.6 inch)
Weight	4.2 kg (9.2 lbs.)

14. Warranty Disclaimer

We guarantee the merchandise manufactured by us to be free from defect in material and workmanship for a period of one year. Our obligation and liability under this warranty shall be restricted to repair or replacement at our factory or local authorized dealer. We assume no liability of the products that are improperly used or used for any purpose other than that for which they are specially designed. This warranty shall not apply to any merchandise which has been repaired, altered or assembled outside our factory in any way so as in our judgment to affect its performance, nor which has been subjected to misuse, negligence, or accident nor to any merchandise operated contrary to our printed instructions. We will not allow or be liable of any loss or any damages of any kind in connection with the use, sale, or repair of any merchandise purchased from us.

15. Machine Dimension







中文使用說明書

1. 前言

在操作本機器之前，請務必仔細詳閱本說明書然後請將本說明書放置在機器使用者可隨時查閱之處存放。此說明書包含如何安全的安裝及操作本機器以及說明所有在機器上的標示。如果您有任何操作上的問題，請立即聯繫當地的 Antari 經銷商尋求協助。

2. 安全注意事項

	危險	若不確實避免這些指示，可能導致嚴重人身傷害甚至死亡。
	警告	若不確實遵循這些指示，可能導致嚴重人身傷害甚至死亡。
	注意	若不確實注意這些指示，可能導致人身傷害甚至死亡，嚴重程度視情況而定。



危險

- 請務必使用正確電壓。如果使用錯誤電壓，可能會遭受危險的電擊燒傷或更嚴重的後果。
- 請務必將機器連結到有保護的電路，並確保有正確地接地，以避免觸電的危險。關於接地方式請參考第 14 頁附錄 I。
- 請勿在捆綁電源線的情況下使用，可能會發熱導致火災。
- 操作機器時請勿將機器對著人體、動物或火焰使用。



警告

- 機器的噴嘴非常燙。當機器工作時，請遠離噴嘴 50 公分以上。
- 請於堅固、平坦、穩定且通風良好的表面上使用機器。請勿遮蓋機器散熱部份，機器周邊至少應保留 50 公分的空間並確認附近沒有易燃性物質或可揮發性氣體。
- 請勿隨意拆卸、修理或改造機器，這可能會導致機器故障、損壞、觸電危險或造成火災。
- 本機器僅限有行為能力之成人或專業人員操作，不預期提供生理、感知、心智能力、經驗或知識不足者之使用者(包含孩童)使用本機器。
- 請勿在無人看管時讓機器運作，並於外出離去時確實關閉電源。
- 孩童應受監督，以確保孩童不能操作或嬉戲玩本機器。
- 請勿將機器倒放或傾斜使用，可能導致機器動作不正常或損壞。
- 請將液體存放在室內孩童無法取得之處，保持通風及避免陽光直射。如果有觸碰眼睛或誤食機器，請立即尋求醫生的協助。



注意

- 本機器無防水設計，請隨時保持機器乾燥、嚴禁將其潑水、浸水、淋雨或放在潮溼的環境。
- 在插入電源插座前，請確認電源插座無損壞或鬆動。

- 若電源線損壞，必須使用原廠電源線或組件進行更換，否則將導致保固無效。
- 請在使用機器之前，先填裝好煙霧油，避免機器幫浦空轉過熱造成損害。機器在搬運前或使用完畢後，請清空油桶。
- 在運輸本機器前，請確認機器的油箱已清空並且包裝完整。(建議使用原廠包裝)
- 本產品僅限室內使用。
- 請勿在電壓不穩定的地區使用本機器。
- 如果機器出現異常聲音或有任何不正常現象時，請立即停止工作，將電源關閉及拔下機器電源線，並請聯繫當地的 Antari 經銷商尋求協助。
- 請勿觸碰機器上轉動零件。
- 只能使用原廠建議或販售之配件。
- 請確認機器不在使用的狀態下電源已關。如果長時間不使用機器，請拔掉電源線。
- 關閉機器時，將所以控制開關轉到(“O”)的位置，然後再將插頭從插座拔除。
- 拔除電源線時，請抓住插頭不是電線。
- 在保養及清潔前請把電源線從插座拔除。
- 在電線或插座有損毀、機器故障或有掉落或損壞的情形發生時，請勿操作機器。請將機器送回最近的維修站，做檢查、維修及電源或機械的調整。
- 為確保機器的使用壽命，請使用 Antari 原廠製造之煙霧油，勿使用其它非 Antari 原廠製造煙霧油或添加劑，否則可能會導致電熱管阻塞和故障。

在使用本機之前，請詳細閱讀機器上的警語標示，說明如下：

上蓋印刷

WARNING! 警告!

HOT NOZZLE! 出煙口高溫!

KEEP AT LEAST 50 CM DISTANCE 請保持至少 50 公分的距離

後蓋印刷

WARNING! 警告!

DISCONNECT POWER BEFORE CHANGING FUSE. 更換保險絲前請務必斷開電源

USE ONLY WITH ADULT SUPERVISION. 僅在成人監督下使用

DO NOT OPERATE WITHOUT LIQUID. 請勿在沒有液體的情況操作本機台

FOR INDOOR USE ONLY. KEEP DRY. 僅限室內使用 請保持乾燥

NO USER SERVICEABLE PARTS INSIDE. 內部無使用者可維修之零配件

LIQUID

ONLY USE MANUFACTURER DESIGNATED FLUID. 僅使用原廠認可的液體

ATTENTION! 注意!

NEVER ADD FLAMMABLE SUBSTANCES. 切勿添加易燃物質

3. 包裝內容與檢查

在收到機器後，請立即小心地打開包裝紙箱，檢查所有內容，確認您所購買的機型及配件。如果有任何部件因運輸過程出現損壞或缺少，請立即連絡經銷商，並以原包裝退回檢查。

3.1 包裝內容

- 1 台 Z-800 III 煙霧機
- 1 條 電源線
- 1 個 Z-10 有線控制器
- 1 本 使用手冊或掃描機身 QR CODE

3.2 選配說明

品項	描述
Z-40	有線定時控制器
Z-50	無線控制器

4. 機器訊息



01. 噴煙口	05. 電源鈕
02. 按鈕	06. 保險絲
03. 手把	07. 電源線
04. 油桶蓋	08. 6.5mm 有線控制器端口

5. 技術標籤資訊

使用本機器前，請詳閱位於機器後方的技術標籤訊息。

<p> 1 XXXXXXXX 2 INPUT VOLTAGE: 3 FREQUENCY: 4 RATED POWER: 5 BREAKER: </p>	<p> XXXVac 50/60Hz XXXXW XA 250V MADE IN TAIWAN XXXXXMMYYXXXXX </p>	<p> 6 [QR Code] Scan It for User Manual </p>
<p> 7 [Barcode] </p>		
1. 機台型號	5. 保險絲規格	
2. 使用電壓	6. 說明書 QR CODE	
3. 頻率	7. 機台流水序號	
4. 瓦特數		

6. 煙霧油

	危險	<p>將液體加入機器之前，請務必先拔除電源線。請勿添加易燃液體。如果發現液體流入機器內部，請洽 Antari 原廠或其經銷商尋求協助。</p>
---	-----------	---

- 僅能使用 Antari 原廠製造之煙霧油，不可混用或稀釋。若因保存不當而變質或使用非原廠煙霧油，將可能造成電熱管堵塞而導致機器故障。
- 本機器是使用專屬的煙霧油做測試與校正來取得最佳的效能。

- 如需更換另一種液體，請在使用前，先將油桶中的液體清空，以避免混合。
- 僅能使用 Antari 原廠製造之香精，並依照原廠建議比例添加(原廠建議比例為 1:1000)，如果使用非原廠的香精或比例添加有誤，將可能造成電熱管阻塞而導致機器故障。
- 如果使用非原廠製造之煙霧油或香精而導致煙霧機損壞將不在保固範圍內。

7. 設定與手動操作說明



警告!

機台掉落可能會造成嚴重傷害，請確保本機台安裝牢固且不會掉落。

- 步驟1.** 將機器平放在堅固、平坦、穩定且通風良好的表面上，機器周圍至少應保留 50 公分的空間並確認附近沒有易燃性物質或可揮發性氣體；
- 步驟2.** 將 ANTARI 原廠煙霧油倒入油桶，並注意不要折到油管；
- 步驟3.** 將機器連接電源插座，連接之前，確認機器背後技術標籤上所標示要求功率，是否與電源插座相符；
- 步驟4.** 啟動機器電源後，機器會開始加溫。機器加溫時，手把上的按鈕的紅色指示燈將會閃爍。機器加溫到可工作溫度大約需要 2 分鐘。當機器達到工作溫度時，紅色指示燈將會靜止，表示機器已經準備好可進行操作；
- 步驟5.** 欲開始噴煙，長按手把上的按鈕；停止噴煙請放開手板上的按鈕按；
- 步驟6.** 需關閉機器時，請確認機器已停止運轉，再將電源關閉即可，長時間不使用時請拔除電源線。
- ****當安裝機器在高架時，請確定所有連接點與索具都已經鎖緊與固定。高架必須要能夠承載至少機器 10 倍的重量。

8. 控制設定

Z-800 III 煙霧機可以使用下列操作模式，機器每次接受一種訊號。當同時間使用多種訊號時機器將根據原廠內建訊號的優先順序來進行工作；

- 有線控制
- 有線定時控制
- 無線控制
- 手動控制

9. Z-10 有線控制器(標配)



Z-10 有線控制器是 Z-800 III 煙霧機的標準配件，使用方法如下；

1. 將有線控制器插入機器後方；
2. 當綠色指示燈靜止不動，表示機器已經可以使用；
3. 長按紅色按鈕開始噴煙，放開紅色按鈕停止噴煙。

******如果有任何問題，請聯繫當地的 Antari 經銷商尋求協助。

10. Z-40 有線定時控制器(選配)



Z-40 有線定時控制器是 Z-800 III 煙霧機的可選配件，使用方法如下；

1. 將有線定時控制器插入機器後方；
2. 按下紅色按鈕開啟控制器電源(紅色指示燈亮起)；如欲關閉控制器電源請再次按下紅色按鈕(紅色指示燈熄滅)；
3. 按下黃色按鈕啟動計時功能(黃色指示燈亮起)；根據你的需求轉動”DURATION”和”INTERVAL”旋鈕。如欲關閉計時功能請再次按下黃色按鈕(黃色指示燈熄滅)；
4. 按下綠色按鈕開始噴煙(綠色指示燈亮起)；再次按下綠色按鈕停止噴煙(綠色指示燈熄滅)。

注意：

- **務必開啟控制器電源才能使用。
- **如果關閉計時功能，還是可以按下綠色按鈕開始噴煙。
- **如果有任何問題，請聯繫當地的 Antari 經銷商尋求協助。

11. Z-50 無線控制器(選配)



Z-50 無線控制器是 Z-800 III 煙霧機的可選配件，它包含一個無線控制器和一個接收器。此配件是隨插即用，不需要做配對，使用方法如下；

1. 將接收器插入機器後方；
2. 長按任何一個紅色按鈕開始噴煙，放開紅色按鈕停止噴煙。

**如果有任何問題，請聯繫當地的 Antari 經銷商尋求協助。

12. 維護和保養



危險!

維修保養之前，請務必拔除電源線！

- 隨時保持機器清潔。
- 可以使用空氣壓縮機、吸塵器或軟刷除去機器上的灰塵。

- 機殼可使用濕布擦拭。
- 在存放或收起機器前，請確認機器完全冷卻，避免機器內部潮濕導致故障。
- 建議每月至少讓機器運轉一次，以保持機器處於最佳的性能和輸出條件。
- 機器上過多的灰塵、液體殘餘累積的髒污會降低機器工作性能，導致散熱不良。

13. 技術規格

Z-800 III	
電壓	美規 : AC 100-120V, 50/60Hz 6.7A 歐規 : AC 220-240V, 50/60Hz 3.5A
額定功率	800 瓦
加熱時間	約 2 分鐘
耗油量	13 毫升/分鐘 (100%輸出)
油桶容量	0.8 公升 (0.21 加侖)
適用煙霧油	Antari FLG 濃煙霧油、Antari FLR 淡煙霧油
適用環境溫度	0°C – 40°C (32°F – 104°F)
控制方式	手動控制、有線控制、有線定時控制、無線控制
介面	N/A
DMX 512 通道	N/A
可選配件	Z-40 有線定時控制器、Z-50 無線控制器
尺寸	長 315 寬 128 高 218 公釐 (長 12.4 寬 5.0 高 8.6 英寸)
重量	4.2 公斤 (9.2 磅)

14. 保固聲明

本公司保證我們的商品在一年內沒有材料和製作缺陷。我們在本保證下的義務和責任僅限於在原廠或當地授權經銷商進行的維修或更換。我們對不當使用或用於非專門設計目的以外之用途不承擔任何責任。本保固不適用於以任何方式在原廠或當地授權經銷商外修理、改動或組裝的任何商品，以便我們判斷影響其性能，沒有受到誤用、疏忽或事故的影響，也沒有違反我們的任何商品操作印刷說明。本公司對於從我們這邊購買的商品不會允許也不對於使用、銷售或修理任何產品有關的任何類型的任何損失或損害承擔責任。

15. 機器尺寸圖



Appendix I Grounding Instruction

This appliance must be grounded. In the event of malfunction or breakdown, grounding provides a path of least resistance for electric current to reduce the risk of electric shock. This appliance is equipped with a cord having an equipment-grounding conductor and a grounding plug. The plug must be plugged into an appropriate outlet that is properly installed and grounded in accordance with all local codes and ordinances.

DANGER – Improper connection of the equipment-grounding conductor can result in a risk of electric shock. The conductor with insulation having an outer surface that is green with or without yellow stripes is the equipment-grounding conductor. If repair or replacement of the cord or plug is necessary, do not connect the equipment-grounding conductor to a live terminal. Check with a qualified electrician or serviceman if the grounding instructions are not completely understood, or if in doubt as to whether the appliance is properly grounded. Do not modify the plug provided with the appliance – if it will not fit the outlet, have a proper outlet installed by a qualified electrician.

This appliance is for use on a nominal 120 V circuit, and has a grounding plug that looks like the plug illustrated in sketch A in Figure. A temporary adaptor, which looks like the adaptor illustrated in sketches B and C, may be used to connect this plug to a 2-pole receptacle as shown in sketch B if a properly grounded outlet is not available. The temporary adaptor should be used only until a properly grounded outlet can be installed by a qualified electrician. The green colored rigid ear, lug, and the like, extending from the adaptor must be connected to a permanent ground such as a properly grounded outlet box cover. Whenever the adaptor is used, it must be held in place by the metal screw.

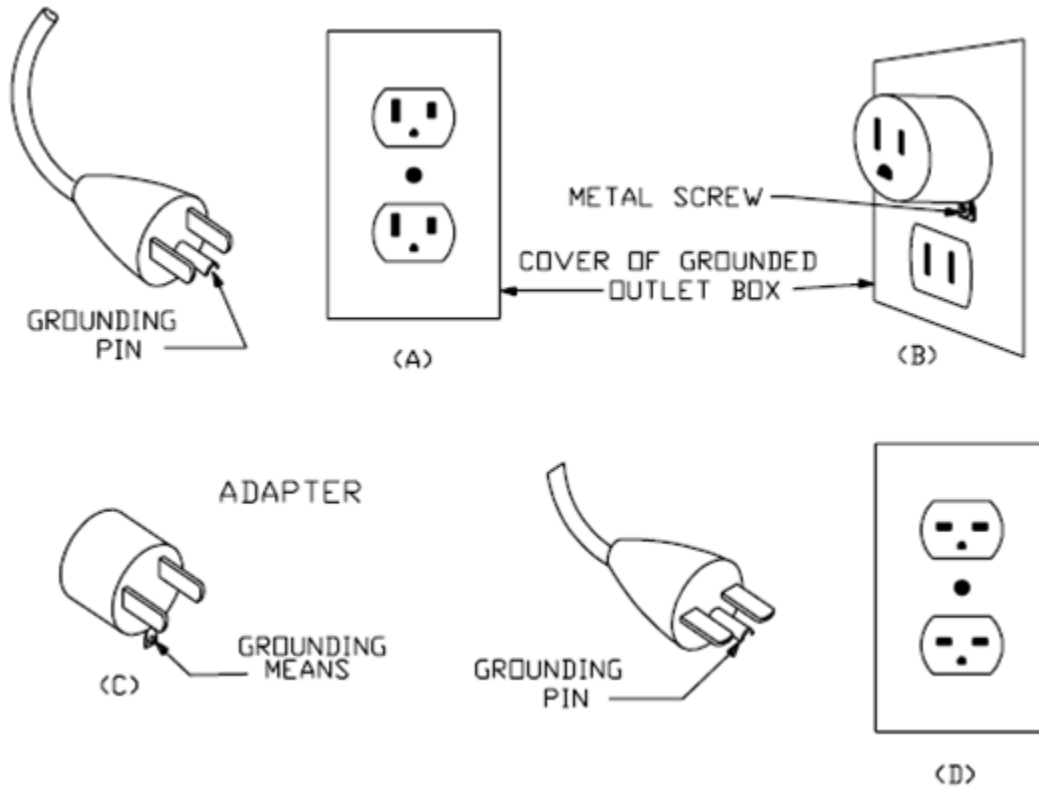



C08Z01000