

ENGLISH

# PSA-16A3S

# V2

Product code: 50661

## Preface

---

Thank you for purchasing this Showgear product.

The purpose of this user manual is to provide instructions for the correct and safe use of this product.

Keep the user manual for future reference as it is an integral part of the product. The user manual shall be stored at an easily accessible location.

This user manual contains information concerning:

- Safety instructions
- Installation and operation of the device
- Intended and non-intended use of the device
- Maintenance procedures
- Troubleshooting
- Transport, storage and disposal of the device

Non-observance of the instructions in this user manual may result in serious injuries and damage of property.

©2021 Showgear. All rights reserved.

No part of this document may be copied, published or otherwise reproduced without the prior written consent of Highlite International.

Design and product specifications are subject to change without prior notice.

For the latest version of this document or other language versions, please visit our website [www.highlite.com](http://www.highlite.com) or contact us at [service@highlite.com](mailto:service@highlite.com).

Highlite International and its authorized service providers are not liable for any injury, damage, direct or indirect loss, consequential or economic loss or any other loss arising from the use of, or inability to use or reliance on the information contained in this document.

## Table of contents

---

<b>1. Introduction</b> .....	<b>3</b>
1.1. Before Using the Product .....	3
1.2. Intended Use .....	3
1.3. Text Conventions .....	3
1.4. Symbols and Signal Words.....	4
1.5. Symbols on the Information Label .....	4
<b>2. Safety</b> .....	<b>5</b>
2.1. Warnings and Safety Instructions .....	5
2.2. Requirements for the User.....	7
<b>3. Description of the Device</b> .....	<b>8</b>
3.1. Front View .....	8
3.2. Back View .....	8
3.3. Product Specifications .....	9
3.4. Dimensions.....	9
<b>4. Installation</b> .....	<b>10</b>
4.1. Safety Instructions for Installation .....	10
4.2. Installation Site Requirements .....	10
4.3. Rack Mounting .....	10
4.4. Connecting to Power Supply .....	11
4.4.1. Schematic Overview .....	11
<b>5. Setup and Operation</b> .....	<b>12</b>
5.1. Warnings and Precautions .....	12
5.2. Safety Instructions for Operation .....	12
5.3. Start-up.....	12
<b>6. Troubleshooting</b> .....	<b>13</b>
<b>7. Maintenance</b> .....	<b>13</b>
7.1. Safety Instructions for Maintenance.....	13
7.2. Preventive Maintenance .....	13
7.2.1. Basic Cleaning Instructions.....	13
7.3. Corrective Maintenance .....	14
<b>8. Deinstallation, Transportation and Storage</b> .....	<b>14</b>
<b>9. Disposal</b> .....	<b>14</b>
<b>10. Approval</b> .....	<b>14</b>

## 1. Introduction

### 1.1. Before Using the Product



#### Important

Read and follow the instructions in this user manual before installing, operating or servicing this product.

The manufacturer will not accept liability for any resulting damages caused by the non-observance of this manual.

After unpacking, check the contents of the box. If any parts are missing or damaged, contact your Highlite International dealer.

Your shipment includes:

- Showgear PSA-16A3S
- User manual

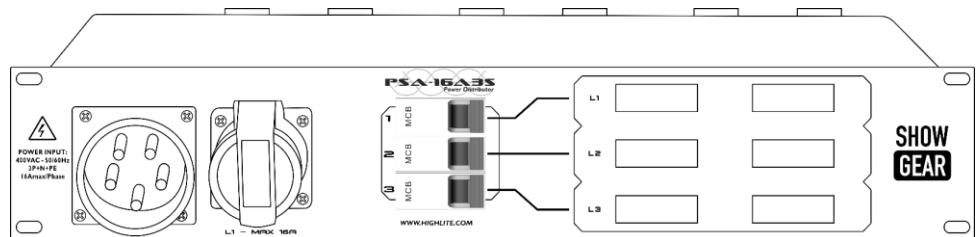

Fig. 01

### 1.2. Intended Use

This device is intended for professional use as a 3-phase power distribution unit in theaters, entertainment facilities, public venues, and similar. It is suitable only for indoor use. This device is not suitable for households and residential buildings.

This device is designed for use in environment B.

Any other use, not mentioned under intended use, is regarded as non-intended and incorrect use.

### 1.3. Text Conventions







Throughout the user manual the following text conventions are used:

- Buttons: All buttons are in bold lettering, for example "Press the **UP/DOWN** buttons"
- References: References to chapters and parts of the device are in bold lettering, for example: "Refer to **2. Safety**", "turn the **adjustment screw (02)**"
- 0–255: Defines a range of values
- Notes: **Note:** (in bold lettering) is followed by useful information or tips

## 1.4. Symbols and Signal Words

Safety notes and warnings are indicated throughout the user manual by safety signs.





Always follow the instructions provided in this user manual.

	<b>DANGER</b>	Indicates an imminently hazardous situation which, if not avoided, will result in death or serious injury.
	<b>WARNING</b>	Indicates a potentially hazardous situation which, if not avoided, could result in death or serious injury.
	<b>CAUTION</b>	Indicates a potentially hazardous situation, which, if not avoided, may result in minor or moderate injury.
	<b>Attention</b>	Indicates important information for the correct operation and use of the product.
	<b>Important</b>	Read and observe the instructions in this document.
	<b>Electrical hazard</b>	
		Provides important information about the disposal of this product.

## 1.5. Symbols on the Information Label

This product is provided with an information label. The information label is located on the backside of the device.

The information label contains the following symbols:

	This device is designed for indoor use.
	This device falls under IEC protection class I.
	This device shall not be treated as household waste.
	Read and follow the instructions in the user manual before installing, operating or servicing the device.
	Caution: Risk of electric shock. Do not open. Caution: To reduce the risk of electric shock, do not remove cover. No user-serviceable parts inside. Refer servicing to qualified personnel.

## 2. Safety



### Important

**Read and follow the instructions in this user manual before installing, operating or servicing this product.**

The manufacturer will not accept liability for any resulting damages caused by the non-observance of this manual.

### 2.1. Warnings and Safety Instructions



#### DANGER

**Electric shock caused by dangerous voltage inside**

- Do not open the device or remove any covers.
- Do not operate the device if the covers or the housing are open. Before operation, check if the housing is firmly closed and all screws are tightly fastened.
- Disconnect the device from electrical power supply before service and maintenance.



#### DANGER

**Electric shock caused by short-circuit**

This device falls under IEC protection class I.

- Make sure that the device is electrically connected to ground (earth). Connect the device only to a socket-outlet with ground (earth) connection.
- Make sure that the power source is equipped with a residual-current device.
- Do not cover the ground (earth) connection.
- Do not bypass the thermostatic switch or fuses.
- Do not let the power cable come into contact with other cables. Handle the power cable and all connections with the mains with caution.
- Do not modify, bend, mechanically strain, put pressure on, pull or heat up the power cable.
- Make sure that the power cable is not crimped or damaged. Examine the power cable periodically for any defects.
- Do not immerse the device in water or other liquids. Do not install the device in a location where flooding may occur.



#### Attention

**Power supply**

- Before connecting the device to the power supply, make sure that the current, voltage and frequency match the input voltage, current and frequency specified on the information label on the device.
- Make sure that the cross-sectional area of the extension cords and power cables is sufficient for the required power consumption of the device.



**Attention**  
**General safety**

- Do not shake the device. Avoid brute force when installing or operating the device.
- If the device is dropped or struck, disconnect the device from the electrical power supply immediately.
- If the device is exposed to extreme temperature variations (e.g. after transportation), do not switch it on immediately. Let the device reach room temperature before switching it on, otherwise it may be damaged by the formed condensation.
- If the device fails to work properly, discontinue the use immediately.



**Attention**  
**For professional use only**  
**This device shall be used only for the purposes it is designed for.**

This device is intended for professional use as a 3-phase power distribution unit in theaters, entertainment facilities, public venues, and similar. Any incorrect use may lead to hazardous situations and result in injuries and material damage.

- This device is not suitable for households and residential buildings.
- This device does not contain user-serviceable parts. Unauthorized modifications to the device will render the warranty void. Such modifications may result in injuries and material damage.



**Attention**  
**Before use, examine the device visually for any defects.**

Make sure that:

- All screws used for installing the device or parts of the device are tightly fastened and are not corroded.
- There are no deformations on housings, fixations and installation points.
- The power cables are not damaged and do not show any material fatigue.



**Attention**  
**Do not expose the device to conditions that exceed the rated IP class conditions.**

This device is IP20 rated. IP (Ingress Protection) 20 class provides protection against solid objects greater than 12 mm, such as fingers, and no protection against harmful ingress of water.

## 2.2. Requirements for the User

**DANGER****This product may not be used by ordinary persons.**

This product may be used only by instructed or skilled persons. Installation and maintenance can be carried out by instructed or skilled persons. Service shall be carried out only by skilled persons. Contact your Highlite International dealer for more information.

Instructed persons have been instructed and trained by a skilled person, or are supervised by a skilled person, for specific tasks and work activities associated with the installation, service and maintenance of this product, so that they can identify risks and take precautions to avoid them.

Skilled persons have training or experience, which enables them to recognize risks and to avoid hazards associated with the installation, service and maintenance of this product.

Ordinary persons are all persons other than instructed persons and skilled persons. Ordinary persons include not only users of the product but also any other persons that may have access to the device or who may be in the vicinity of the device.



### 3. Description of the Device

The PSA-16A3S is a 3-phase power distribution unit, providing real-time voltage and amperage information during your show. It has 7 Schuko outputs (divided over 3 phases) and a 5-pin CEE input. The maximum allowed current load is 16 A per phase. The maximum allowed current load per output is 16 A.

#### 3.1. Front View

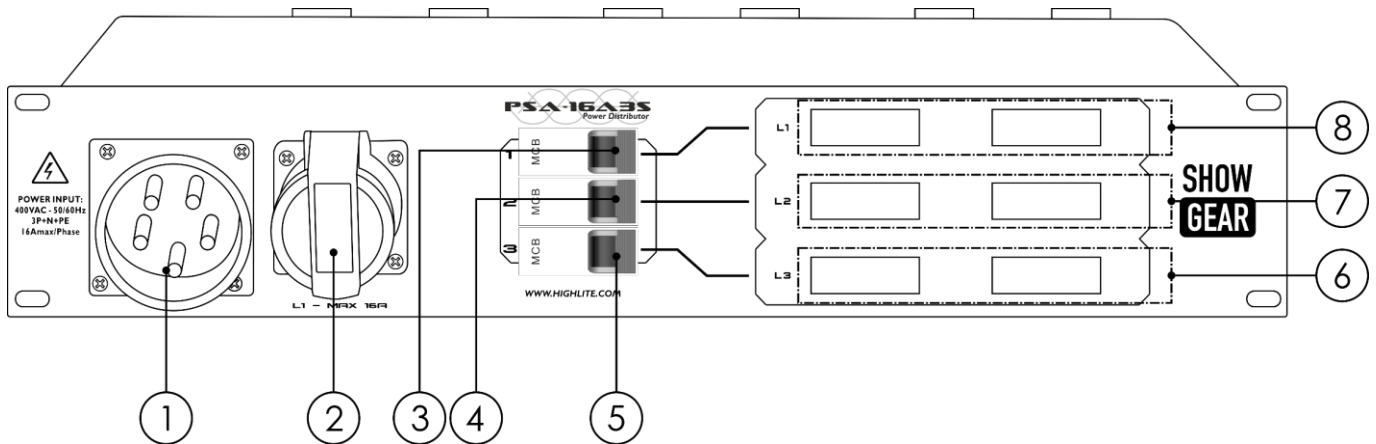

Fig. 02

- 01) 5-pin CEE power IN
- 02) Schuko L1 OUT
- 03) L1 Main Circuit Breaker (MCB)
- 04) L2 Main Circuit Breaker (MCB)
- 05) L3 Main Circuit Breaker (MCB)
- 06) L3 voltage & amperage LED display
- 07) L2 voltage & amperage LED display
- 08) L1 voltage & amperage LED display

#### 3.2. Back View

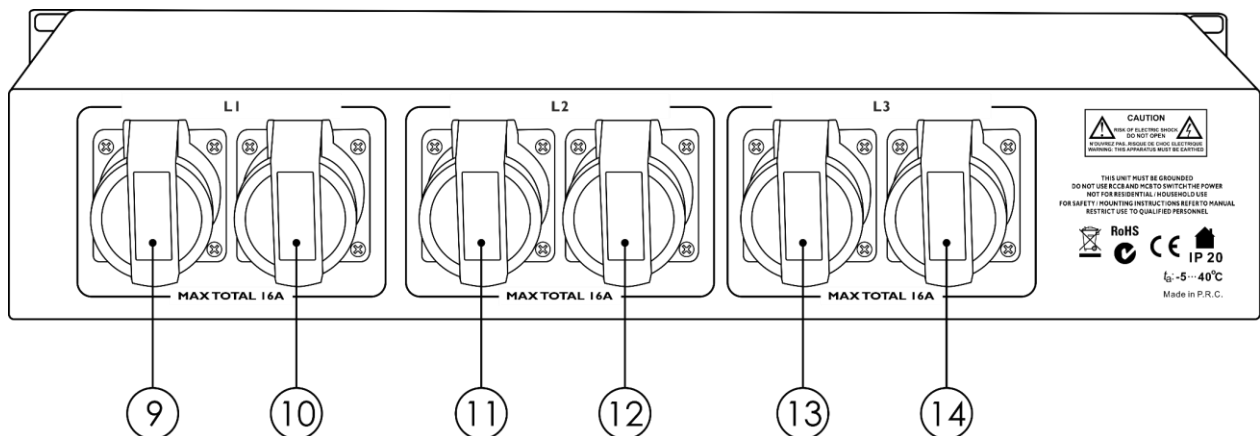

Fig. 03

- 09) Schuko L1 OUT
- 10) Schuko L1 OUT
- 11) Schuko L2 OUT
- 12) Schuko L2 OUT
- 13) Schuko L3 OUT
- 14) Schuko L3 OUT

### 3.3. Product Specifications

Model:	PSA-16A3S	
<b>Electrical:</b>		
Rated current:	16 A	
MCB rated current:	16 A	
MCB class:	Class C	
MCB poles:	1	
Conductors:	5	
Breaking capacity:	6kA	
<b>Inputs/Outputs:</b>		
Power connector IN:	1 x CEE male 3P+N+PE, 400 V AC, 50/60 Hz	
Power connector OUT:	7 x Schuko 1P+N+PE, 230 V AC, 50/60 Hz	
<b>Physical:</b>		
Dimensions:	482 x 211 x 88 mm (LxWxH) 19" x 2 U (LxH)	
Weight:	4,9 kg	
<b>Operation and control:</b>		
Control panel:	7-segment LED display	
<b>Construction:</b>		
Housing:	Metal	
Color:	Gray	
IP rating:	IP20	
<b>Thermal:</b>		
Ambient temperature $t_a$ :	From -5 °C to 35 °C	

### 3.4. Dimensions

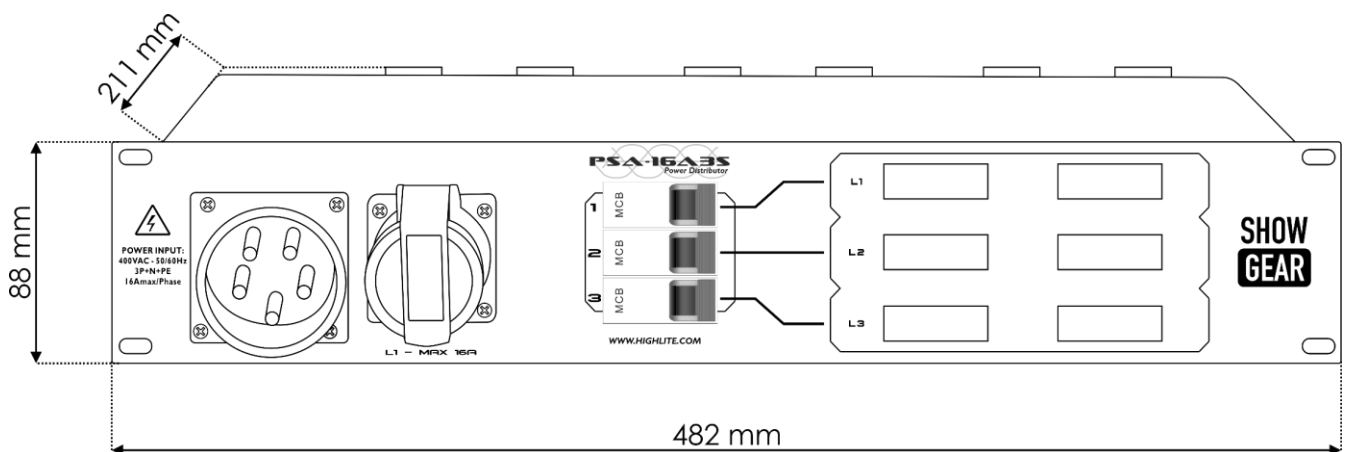

Fig. 04

## 4. Installation

### 4.1. Safety Instructions for Installation

**WARNING**

Incorrect installation can cause serious injuries and damage of property.

Installation must be carried out only by instructed or skilled persons.

Follow all applicable European, national and local safety regulations concerning electrical installations.

**Attention**

Make sure there is enough space for ventilation around the device.

### 4.2. Installation Site Requirements

- The device must be installed only indoors.
- The device can be placed on a flat surface or mounted in a standard 19-inch rack.
- The maximum ambient temperature  $t_a = 35\text{ °C}$  must never be exceeded.
- The relative humidity must not exceed 50 % with an ambient temperature of 35 °C.

### 4.3. Rack Mounting

The device can be mounted in a standard 19-inch rack. The device requires 2 rack units (RU) of space. 1 rack unit is 44,45 mm high.

Make sure that the rack is sufficiently secured to prevent it from becoming unstable or falling over.

To mount the device in a two-post rack, follow the steps below:

- 01) Insert 4 cage nuts in the openings on the rack posts where you want to mount the device.
- 02) Position the device in front of the rack posts so that the 4 mounting openings on the flanges face the openings on the rack posts with cage nuts.
- 03) Using a screwdriver, mount the device to the rack posts with 4 screws.

## 4.4. Connecting to Power Supply



**DANGER**  
Electric shock caused by short-circuit

The device accepts AC mains power at 400 V and 50/60 Hz. Do not supply power at any other voltage or frequency to the device.

This device falls under IEC protection class I. Make sure that the device is always electrically connected to the ground (earth).

Before connecting the device to the socket-outlet:

- Make sure that the power supply matches the input voltage specified on the information label on the device.
- Make sure that the socket-outlet has ground (earth) connection.
- Make sure that the power source is equipped with a residual-current device.

Connect the device to the socket-outlet with a 3 x 16 A CEE H07RN-F cable.

### 4.4.1. Schematic Overview

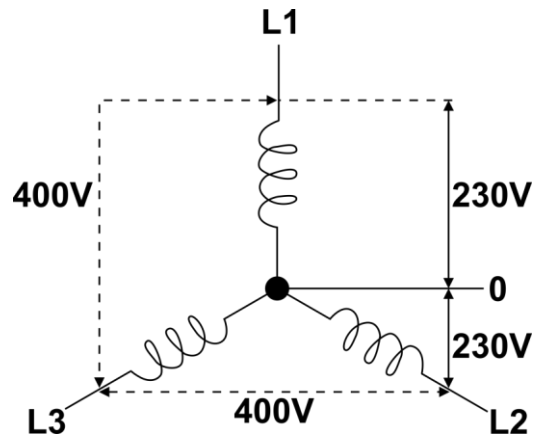

Fig. 05

## 5. Setup and Operation

### 5.1. Warnings and Precautions

**Attention**

Connect all cables before supplying power.  
Disconnect power supply before connecting or disconnecting cables.

### 5.2. Safety Instructions for Operation

**Attention**

This device must be used only for the purposes it is designed for.

This device is intended for professional use as a 3-phase power distribution unit in theaters, entertainment facilities, public venues, and similar. It is suitable only for indoor use. This device is not suitable for households and residential buildings.

This device is designed for use in environment B.

Any other use, not mentioned under intended use, is regarded as non-intended and incorrect use.

**Attention**

Power supply

Before connecting the device to the power supply, make sure that the current, voltage and frequency match the input voltage, current and frequency specified on the information label on the device.

Do not use the circuit breakers as an on/off switch, to switch on the devices connected to the outputs. Switch these devices on only after you have set all the circuit breakers to ON position.

### 5.3. Start-up

- 01) Connect the device to the power supply using the **CEE connector IN (01)**.
- 02) Move the **main circuit breakers (03/04/05)** to ON position.
- 03) Connect external devices to the **Schuko connectors OUT (02/09/10/11/12/13/14)**.
- 04) Switch on the external devices.

## 6. Troubleshooting

This troubleshooting guide contains solutions to problems which can be carried out by an ordinary person. The device does not contain user-serviceable parts.

Unauthorized modifications to the device will render the warranty void. Such modifications may result in injuries and material damage.

Refer servicing to instructed or skilled persons. Contact your Highlite International dealer in case the solution is not described in the table.

Problem	Probable cause(s)	Solution
The device does not function at all	No power to the device	<ul style="list-style-type: none"> <li>• Check if power is switched on and cables are plugged in</li> </ul>
	The main circuit breakers are in OFF position	<ul style="list-style-type: none"> <li>• Check the total current load of the connected devices.</li> <li>• Check if the external devices connected to the outputs are not damaged</li> <li>• Move the main circuit breakers to ON position.</li> </ul>

## 7. Maintenance

### 7.1. Safety Instructions for Maintenance



**DANGER**  
Electric shock caused by dangerous voltage inside

Disconnect power supply before servicing or cleaning.

### 7.2. Preventive Maintenance



**Attention**  
Before use, examine the device visually for any defects.

Make sure that:

- All screws used for installing the device or parts of the device are tightly fastened and are not corroded.
- There are no deformations on housings, fixations and installation points.
- The power cables are not damaged and do not show any material fatigue.

#### 7.2.1. Basic Cleaning Instructions

To clean the device, follow the steps below:

- 01) Disconnect the device from the electrical power supply.
- 02) Allow the device to cool down for 5 minutes.
- 03) Clean the device with a soft, lint-free cloth.



### Attention

- Do not immerse the device in liquid.
- Do not use alcohol or solvents.

## 7.3. Corrective Maintenance

The device does not contain user-serviceable parts. Do not open the device and do not modify the device.

Refer repairs and servicing to instructed or skilled persons. Contact your Highlite International dealer for more information.

## 8. Deinstallation, Transportation and Storage

- Disconnect power supply before deinstallation.
- Use the original packaging to transport the device, if possible.
- Clean the device before storing. Follow the cleaning instructions in chapter **7.2.1. Basic Cleaning Instructions** on page 13.
- Store the device in the original packaging, if possible.

## 9. Disposal

### Correct disposal of this product

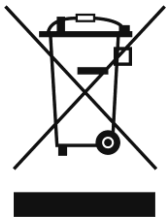

### Waste Electrical and Electronic Equipment

This symbol on the product, its packaging or documents indicates that the product shall not be treated as household waste. Dispose of this product by handing it to the respective collection point for recycling of electrical and electronic equipment. This is to avoid environmental damage or personal injury due to uncontrolled waste disposal. For more detailed information about recycling of this product contact the local authorities or the authorized dealer.

## 10. Approval



Check the respective product page on the website of Highlite International ([www.highlite.com](http://www.highlite.com)) for an available declaration of conformity.

---

**SHOW  
GEAR**

©2021 Showgear