



JOLT PANEL FX



User Manual

©2022 ADJ Products, LLC all rights reserved. Information, specifications, diagrams, images, and instructions herein are subject to change without notice. ADJ Products, LLC logo and identifying product names and numbers herein are trademarks of ADJ Products, LLC. Copyright protection claimed includes all forms and matters of copyrightable materials and information now allowed by statutory or judicial law or hereinafter granted. Product names used in this document may be trademarks or registered trademarks of their respective companies and are hereby acknowledged. All non-ADJ Products, LLC brands and product names are trademarks or registered trademarks of their respective companies.

ADJ Products, LLC and all affiliated companies hereby disclaim any and all liabilities for property, equipment, building, and electrical damages, injuries to any persons, and direct or indirect economic loss associated with the use or reliance of any information contained within this document, and/or as a result of the improper, unsafe, insufficient and negligent assembly, installation, rigging, and operation of this product.

DOCUMENT VERSION



Due to additional product features and/or enhancements, an updated version of this document may be available online.

Please check www.adj.com for the latest revision/update of this manual before beginning installation and/or programming.

Date	Document Version	Software Version	DMX Channels	Notes
01/24/2022	1.0	1.0	6/9/13/18/36/41/126 / 141 channels	Initial Release

Europe Energy Saving Notice

Energy Saving Matters (EuP 2009/125/EC)

Saving electric energy is a key to help protecting the environment. Please turn off all electrical products when they are not in use. To avoid power consumption in idle mode, disconnect all electrical equipment from power when not in use. Thank you!

TABLE OF CONTENTS

Introduction	4
Limited Warranty (USA Only)	5
Warranty Registration Features	6
Safety Guidelines	7
Overview	8
Installation	9
Remove Device Management	11
Control Panel	12
System Menu	13
DMX Setup	15
DMX Traits	17
LED Pixel Zones	24
Dimmer Modes and Curves	25
Daisy Chain Power Linking Cleaning and Maintenance	26
Software Update Instructions	27
Dimensional Drawings	28
Specifications	29

INTRODUCTION

Unpacking: Thank you for purchasing the Jolt Panel FX by ADJ Products, LLC. Every device has been thoroughly tested and has been shipped in perfect operating condition. Carefully check the shipping carton for damage that may have occurred during shipping. If the carton appears to have been damaged, carefully inspect your fixture for any damage and be sure all accessories necessary to operate the unit have arrived intact. In the event that damage has been found or parts are missing, please contact our toll free customer support number for further instructions. Do not return this unit to your dealer without first contacting customer support.

Introduction: The ADJ Jolt Panel FX is a DMX intelligent, high powered LED fixture. To optimize the performance of this product, please read these operating instructions carefully to familiarize yourself with the basic operations of this unit. These instructions contain important safety information regarding the use and maintenance of this unit. Please keep this manual with the unit for future reference.

Customer Support: Contact ADJ Service for any product related service and support needs. Also visit forums.adj.com with questions, comments or suggestions.

Parts: To purchase parts online visit:

<http://parts.adj.com> (US)

<http://www.adjparts.eu> (EU)

ADJ SERVICE USA - Monday - Friday 8:00am to 4:30pm PST

Voice: 800-322-6337 | Fax: 323-582-2941 | support@adj.com

ADJ SERVICE EUROPE - Monday - Friday 08:30 to 17:00 CET

Voice: +31 45 546 85 60 | Fax: +31 45 546 85 96 | support@adj.eu

ADJ PRODUCTS LLC USA

6122 S. Eastern Ave. Los Angeles, CA. 90040

323-582-2650 | Fax 323-532-2941 | www.adj.com | info@adj.com

ADJ SUPPLY Europe B.V

Junostraat 2 6468 EW Kerkrade, The Netherlands

+31 (0)45 546 85 00 | Fax +31 45 546 85 99

www.adj.eu | info@adj.eu

ADJ PRODUCTS GROUP Mexico

AV Santa Ana 30 Parque Industrial Lerma, Lerma, Mexico 52000

+52 (728) 282-7070

CAUTION! This device is intended for indoor use only! Do not expose to rain or moisture!

CAUTION! There are no user serviceable parts inside this unit. Do not attempt any repairs yourself, as doing so will void your manufacturer's warranty. In the unlikely event that your unit requires service, please contact ADJ Products, LLC.

Do not discard the shipping carton in the trash. Please recycle when ever possible.

LIMITED WARRANTY (USA ONLY)

- A. ADJ Products, LLC hereby warrants, to the original purchaser, ADJ Products, LLC products to be free of manufacturing defects in material and workmanship for a prescribed period from the date of purchase (see specific warranty period on reverse). This warranty shall be valid only if the product is purchased within the United States of America, including possessions and territories. It is the owner's responsibility to establish the date and place of purchase by acceptable evidence, at the time service is sought.
- B. For warranty service, you must obtain a Return Authorization number (RA#) before sending the product back—please contact ADJ Products, LLC Service Department at 800-322-6337. Send the product only to the ADJ Products, LLC factory. All shipping charges must be prepaid. If the requested repairs or service (including parts replacement) are within the terms of this warranty, ADJ Products, LLC will pay return shipping charges only to a designated point within the United States. If the entire instrument is sent, it must be shipped in its original package and packaging material. No accessories should be shipped with the product. If any accessories are shipped with the product, ADJ Products, LLC shall incur no liability whatsoever for loss of or damage to any such accessories, nor for the safe return thereof.
- C. This warranty is void if the product serial number and/or labels are altered or removed; if the product is modified in any manner which ADJ Products, LLC concludes, after inspection, affects the reliability of the product; if the product has been repaired or serviced by anyone other than the ADJ Products, LLC factory unless prior written authorization was issued to purchaser by ADJ Products, LLC; if the product is damaged because it was not properly maintained as set forth in the product instructions, guidelines and/or user manual.
- D. This is not a service contract, and this warranty does not include maintenance, cleaning, or periodic checkup. During the period specified above, ADJ Products, LLC will replace defective parts at its expense with new or refurbished parts, and will absorb all expenses for warranty service and repair labor by reason of defects in material or workmanship. The sole responsibility of ADJ Products, LLC under this warranty shall be limited to the repair of the product, or replacement thereof, including parts, at the sole discretion of ADJ Products, LLC. All products covered by this warranty were manufactured after August 15, 2012, and bear identifying marks to that effect.
- E. ADJ Products, LLC reserves the right to make changes in design and/or improvements upon its products without any obligation to include these changes in any products theretofore manufactured.
- F. No warranty, whether expressed or implied, is given or made with respect to any accessory supplied with products described above. Except to the extent prohibited by applicable law, all implied warranties made by ADJ Products, LLC in connection with this product, including warranties of merchantability or fitness, are limited in duration to the warranty period set forth above. And all warranties, whether expressed or implied, including warranties of merchantability or fitness, are limited in duration to the warranty period set forth above. The consumer's and/or dealer's sole remedy shall be such repair or replacement as is expressly provided above; and under no circumstances shall ADJ Product, LLC be liable for any loss and/or damage, direct and/or consequential arising out of the use of, and/or inability to use this product.
- G. This warranty is the only written warranty applicable to ADJ Products, LLC products, and supersedes all prior warranties and written descriptions of warranty terms and conditions heretofore published.

MANUFACTURER'S LIMITED WARRANTY PERIODS:

- Non-LED Lighting Products = 1-Year (365 Days) (Including Special Effect Lighting, Intelligent Lighting, UV lighting, Strobes, Fog Machines, Bubble Machines, Mirror Balls, Par Cans, Trussing, Lighting Stands, Power/Data Distribution, etc. excluding LED and lamps)
- Laser Products = 1-Year (365 Days) (excluding laser diodes which have a 6-Month Limited Warranty)
- LED Products = 2-Year (730 Days) (excluding batteries which have a 180 Day Limited Warranty)
- NOTE: 2-Year (730 Days) Limited Warranty ONLY applies to product purchased within the United States.
- StarTec Series = 1-Year (365 Days) (excluding batteries which have a 180 Day Limited Warranty)
- ADJ DMX Controllers = 2 Year (730 Days)
- American Audio Products = 1 Year (365 Days)

WARRANTY REGISTRATION

The Jolt Panel FX carries a 2 year limited warranty. Please fill out the enclosed warranty card to validate your purchase. All returned service items, whether under warranty or not, must be freight prepaid and accompanied by a return authorization (R.A.) number. The R.A. number must be clearly written on the outside of the return package. A brief description of the problem as well as the R.A. number must also be written down on a piece of paper included in the shipping carton. If the unit is under warranty, you must provide a copy of your proof of purchase invoice. You may obtain an R.A. number by contacting our customer support team on our customer support number. All packages returned to the service department not displaying an R.A. number on the outside of the package will be returned to the shipper.

FEATURES

The Jolt Panel FX is an extremely versatile fixture ideal for concert tours, one-off event production and permanent nightclub installations. It features a central strip of 48 x 5-Watt cool white SMD LEDs, surrounded on both sides by a total of 800 x 0.3W RGB SMD LEDs. This provides lighting designers with the creative potential of generating both strikingly bright white strobe effects and vibrant color washes from the same compact fixture.

- Compact size, light weight construction
- Two types of LEDs: 48 x cool white LED in the center, and 800 x 5050 RGB components in the outer portion of the display
- 40 x LED zones and 6 x strobe tube zones with individual control capability
- Smooth dimming and color mixing
- Ultra-high stunning output with multiple strobe speeds

INCLUDED ITEMS:

- 1 x Locking power cable
- 1 x Omega bracket
- 1 x Single yoke

IP RATING

This device is IP20 rated. This means that the unit is protected against the intrusions of solids approximately the size of an adult finger (2.5mm) or larger, but ***the unit is not protected against water or liquid intrusion of any kind.***

SAFETY GUIDELINES

THIS FIXTURE IS COMPOSED OF SOPHISTICATED ELECTRONIC COMPONENTS. TO GUARANTEE SMOOTH OPERATION, IT IS IMPORTANT TO FOLLOW ALL INSTRUCTIONS AND GUIDELINES IN THIS MANUAL. ADJ PRODUCTS, LLC IS NOT RESPONSIBLE FOR INJURY AND/OR DAMAGES RESULTING FROM THE MISUSE OF THIS FIXTURE DUE TO THE DISREGARD OF THE INFORMATION PRINTED IN THIS MANUAL. ONLY QUALIFIED AND/OR CERTIFIED PERSONNEL SHOULD PERFORM INSTALLATION OF THIS FIXTURE AND ONLY THE ORIGINAL RIGGING PARTS INCLUDED WITH THIS FIXTURE SHOULD BE USED FOR INSTALLATION. ANY MODIFICATIONS TO THE FIXTURE AND/OR THE INCLUDED MOUNTING HARDWARE WILL VOID THE ORIGINAL MANUFACTURER'S WARRANTY AND INCREASE THE RISK OF DAMAGE AND/OR PERSONAL INJURY. ONLY CERTIFIED PERSONNEL SHOULD PERFORM INSTALLATION OF THIS FIXTURE.

- PROTECTION CLASS 1 - FIXTURE MUST BE PROPERLY GROUNDED.
- THERE ARE NO USER SERVICEABLE PARTS INSIDE THIS UNIT.
- DO NOT ATTEMPT ANY REPAIRS YOURSELF; DOING SO WILL VOID YOUR MANUFACTURER'S WARRANTY. DAMAGES RESULTING FROM MODIFICATIONS TO THIS FIXTURE AND/OR THE DISREGARD OF SAFETY INSTRUCTIONS AND GUIDELINES IN THIS MANUAL VOID THE MANUFACTURER'S WARRANTY AND ARE NOT SUBJECT TO ANY WARRANTY CLAIMS AND/OR REPAIRS.
- DO NOT PLUG FIXTURE INTO A DIMMER PACK!
- NEVER OPEN THIS FIXTURE WHILE IN USE!
- UNPLUG POWER BEFORE SERVICING FIXTURE!
- NEVER TOUCH FIXTURE DURING OPERATION, AS IT MAY BE HOT!
- KEEP FLAMMABLE MATERIALS AWAY FROM FIXTURE!
- NEVER LOOK DIRECTLY INTO THE LIGHT SOURCE!
- RETINA INJURY RISK - MAY INDUCE BLINDNESS!
- SENSITIVE PERSONS MAY SUFFER AN EPILEPTIC SHOCK!
- INDOOR / DRY LOCATIONS USE ONLY!
- DO NOT EXPOSE FIXTURE TO RAIN AND MOISTURE!
- MINIMUM DISTANCE TO OBJECTS/SURFACES IS 6.6 FEET (2 METERS)
- MINIMUM DISTANCE TO FLAMMABLE MATERIALS FROM THE SURFACE IS 1.6 FEET (0.5 METER).
- DO NOT TOUCH the fixture housing during operation. Turn OFF the power and allow approximately 60 minutes for the fixture to cool down before serving.
- DO NOT shake fixture, and avoid brute force when installing and/or operating fixture.
- DO NOT operate fixture if the power cord is frayed, crimped, damaged and/or if any of the power cord connectors are damaged and do not insert into the fixture securely with ease. NEVER force a power cord connector into the fixture. If the power cord or any of its connectors are damaged, replace it immediately with a new one of the same power rating.
- DO NOT block any air ventilation slots. All fan and air inlets must remain clean and never blocked. Allow approx. 6" (15cm) between fixture and other devices or a wall for proper cooling.
- When installing fixture in a suspended environment, always use mounting hardware that is no less than M10 x 25 mm, and always install fixture with an appropriately rated safety cable.
- Always disconnect fixture from main power source before performing any type of service and/or cleaning procedure.
- Only handle the power cord by the plug end. Never pull out the plug by tugging the wire portion of the cord.
- During the initial operation of this fixture, a light smoke or smell may emit from the interior of the fixture. This is a normal process and is caused by excess paint in the interior of the casing burning off from the heat associated with the lamp and will decrease gradually over time.
- Consistent operational breaks will ensure fixture will function properly for many years.
- Only use original packaging and materials to transport the fixture in for service.

OVERVIEW

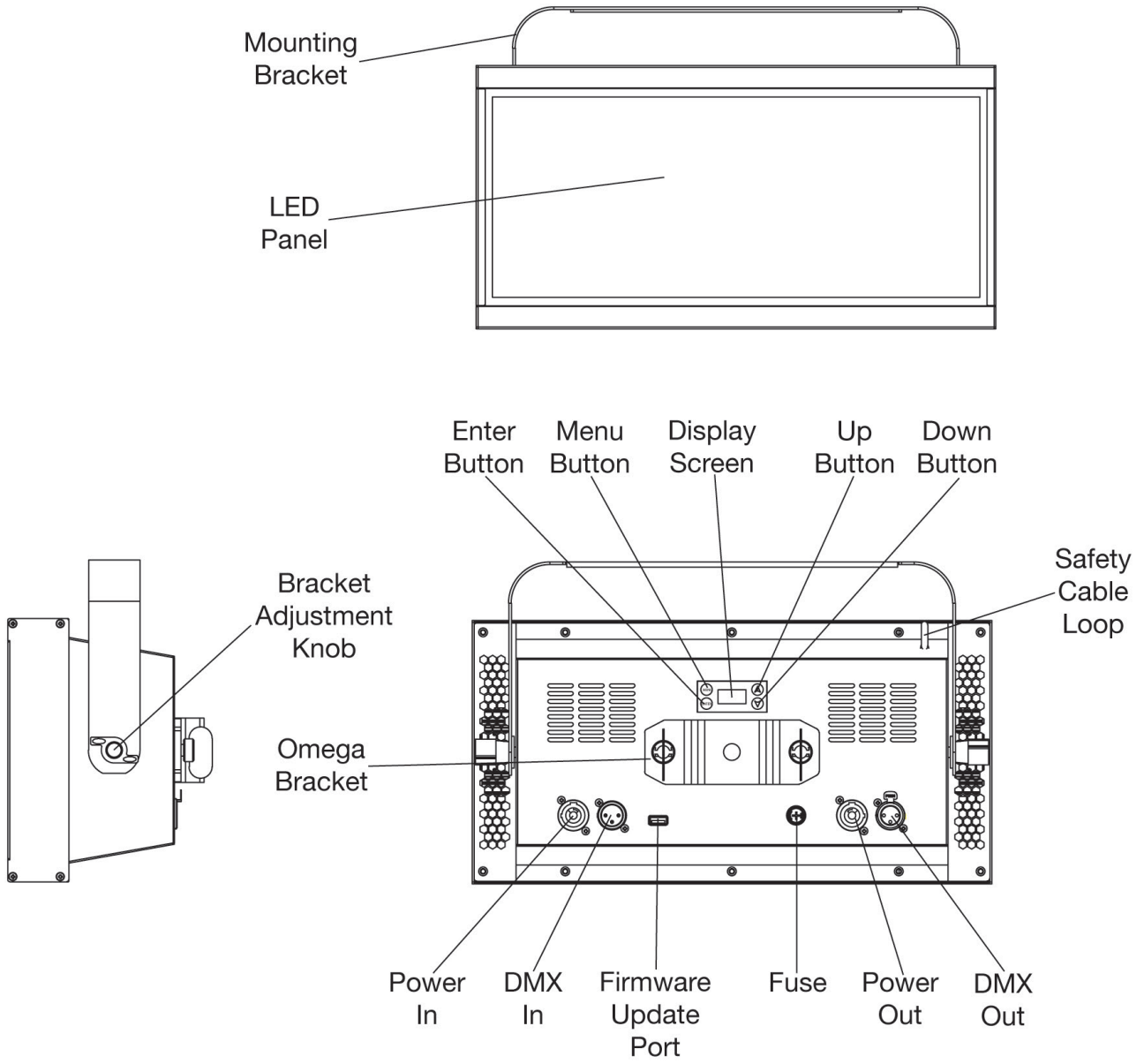

INSTALLATION



FLAMMABLE MATERIAL WARNING

Keep fixture minimum 5.0 feet (1.5m) away from flammable materials and/or pyrotechnics.



ELECTRICAL CONNECTIONS

A qualified electrician should be used for all electrical connections and/or installations.



MINIMUM DISTANCE TO OBJECTS/SURFACES IS 6.6 FEET (2 METERS).

MINIMUM DISTANCE OF INFLAMMABLE MATERIALS FROM THE SURFACE IS 1.6 FEET (0.5 METER)

DO NOT INSTALL THE FIXTURE IF YOU ARE NOT QUALIFIED TO DO SO!

- Fixture **MUST** be installed following all local, national, and country commercial electrical and construction codes and regulations.
- Before rigging/mounting a single fixture or multiple fixtures to any metal truss/structure or placing the fixture(s) on any surface, a professional equipment installer **MUST** be consulted to determine if the metal truss/structure or surface is properly certified to safely hold the combined weight of the fixture(s), clamps, cables, and accessories.
- Maximum ambient operating temperature is **113°F (45°C)**. Do not use fixture when ambient temperature exceeds this value.
- Fixture(s) should be installed outside walking paths, seating areas, or areas where unauthorized personnel might reach the fixture by hand.
- **NEVER** stand directly below the fixture(s) when rigging, removing, or servicing.
- Overhead fixture installation must always be secured with a secondary safety attachment, such as an appropriately rated safety cable.
- Allow approximately 60 minutes for the fixture to cool down before servicing.

IP RATING

This device is IP20 rated. This means that the unit is protected against the intrusion of solids 2.5mm in size or larger (approximately the size of an adult finger tip). The unit is NOT protected against water or liquid intrusion of any kind!

RIGGING

Overhead rigging requires extensive experience, including calculating working load limits, knowledge of installation material being used, and periodic safety inspection of all installation material and the fixture, among other skills. If you lack these qualifications, do not attempt the installation yourself. Improper installation can result in bodily injury.

INSTALLATION

CLAMP INSTALLATION

This fixture features a mounting point on the yoke for the attachment of a mounting clamp. There is also a safety cable loop located on the rear of the fixture (see the illustration below). When mounting the fixture to a truss or any other suspended or overhead installation, be sure to secure appropriately rated clamps (not included) to the yoke, and attach a separate SAFETY CABLE of the appropriate weight rating to the safety cable loop.

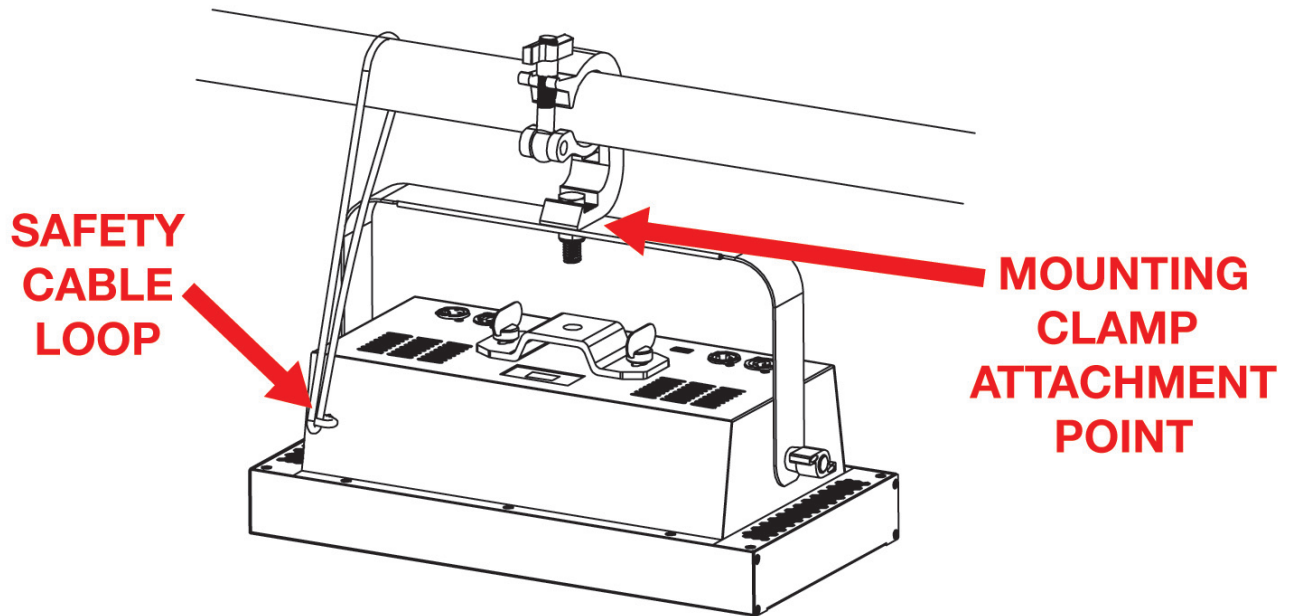

SAFETY CABLE:
ALWAYS ATTACH A SAFETY CABLE WHENEVER INSTALLING THIS FIXTURE IN A SUSPENDED ENVIRONMENT TO ENSURE THAT THE FIXTURE WILL NOT FALL IF THE CLAMP FAILS.

REMOTE DEVICE MANAGEMENT

NOTE: In order for RDM to work properly, RDM enabled equipment must be used throughout the entire system, including DMX data splitters and wireless systems.

Remote Device Management (RDM) is a protocol that sits on top of the DMX512 data standard for lighting, and allows the DMX systems of the fixtures to be modified and monitored remotely. This protocol is ideal for instances in which a unit is installed in a location that is not easily accessible.

With RDM, the DMX512 system becomes bi-directional, allowing a compatible RDM enabled controller to send out a signal to devices on the wire, as well as allowing the fixture to respond (known as a GET command). The controller can then use its SET command to modify settings that would typically have to be changed or viewed directly via the unit's display screen, including the DMX Address, DMX Channel Mode, and Temperature Sensors.

Please be aware that **not all RDM devices support all RDM features**, and therefore it is important to check beforehand to ensure that the equipment that you are considering includes all of the features that you require.

The following parameters are accessible in RDM on this device:

MANUFACTURER
SOFTWARE VERSION
DMX START ADDRESS
DEVICE MODEL DESCRIPTION
DEVICE LABEL
DMX PERSONALITY
DMX PERSONALITY DESCRIPTION
DEVICE HOURS
RESET DEVICE - WARM RESET
RESET DEVICE - COLD RESET

CONTROL PANEL

The fixture includes an easy to navigate system menu control panel display where all necessary settings and adjustments are made. (See image below)

- **MENU:** Leave current menu and return to previous menu level.
- **UP:** Scroll up in currently displayed menu.
- **DOWN:** Scroll down in currently displayed menu.
- **ENTER:** Select an option or confirm a selection.

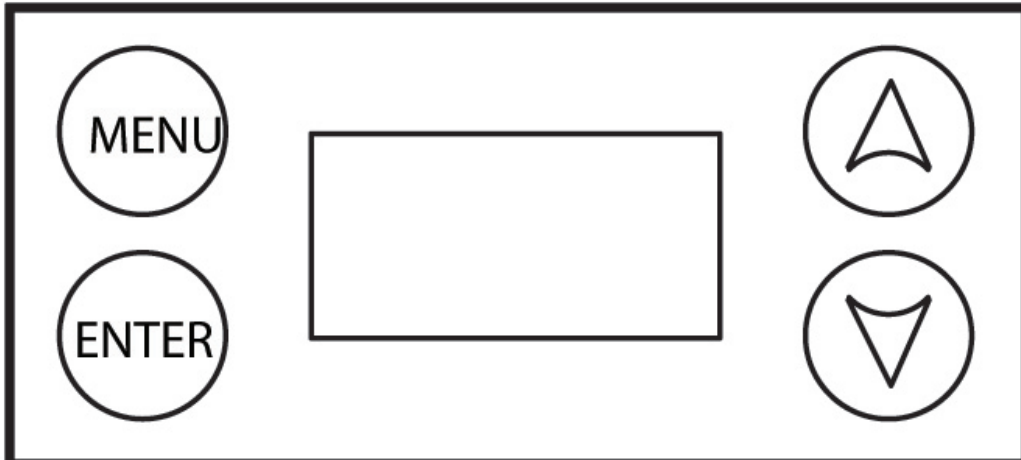

This fixture includes a display lock feature which automatically shuts off the display screen after a certain period of inactivity. This feature is OFF by default, which means that the display will always remain on regardless of inactivity, but can be configured to kick in after up to 10 minutes of inactivity. See the **System Menu** section of this manual for details on how to configure this setting.

SYSTEM MENU

DMX SETTINGS	DMX Address	1 - 507 (6ch)			
		1 - 504 (9ch)			
		1 - 500 (13ch)			
		1 - 495 (18ch)			
		1 - 477 (36ch)			
		1 - 472 (41ch)			
		1 - 387 (126ch)			
		1 - 372 (141ch)			
	DMX Channel Mode	6CH			
		9CH			
		13CH			
		18CH			
		36CH			
		41CH			
		126CH			
		141CH			
	No DMX Status	Blackout		Takes all traits to 0 when DMX signal is lost or interrupted.	
		Hold		Holds all traits at last received value when DMX signal is lost or interrupted.	
		Manual		Defaults to values set in Manual Mode when DMX signal is lost or interrupted.	
	PERSONALITY	Dim Modes	Standard		
			Stage		
TV					
Architectural					
Theatre					
Stage 2					
Dimmer Curve		Linear			
		Square			
		Inv. Sq.			
		S-Curve			
Display		Display Backlight	Off - 2 min		
		Display Lock	Off - 10 min		
		Display Invert	No / Yes		
CONTINUED ON NEXT PAGE					

SYSTEM MENU

PERSONALITY (continued)	Temperature Unit	°C / °F			
	Fan Speed	Low			
		High			
		Auto			
	Service (Passcode = 011)	White Balance	Red1 (000 - 255)		
			Green1 (000 - 255)		
			Blue1 (000 - 255)		
			Red2 (000 - 255)		
			Green2 (000 - 255)		
			Blue2 (000 - 255)		
			...		
		USB Port Power	ON / OFF		
	Update Software	Yes / No			
Factory Restore	Yes / No				
MANUAL	Outer Red	000 - 255		Note: Manual control settings shall always hold when no DMX signal is detected.	
	Outer Green	000 - 255			
	Outer Blue	000 - 255			
	Inner White	000 - 255			
	Dimmer	000 - 255			
	Dimmer Fine	000 - 255			
	Strobe Effect	000 - 255			
	Strobe Rate	000 - 255			
	Strobe Duration	000 - 255			
FIXTURE TEST	Auto Test				
FIXTURE INFORMATION	Fixture Use Hour				
	LED Use Hour	Total LED Hour			
		LED On Hour			
		LED Hours Reset			
	Temperature				
	Fan State				
	RDM UID	xxxxxx			
	Error Logs	Fixture Errors	LED Fan Error		
			Temperature Error		
		Reset Error Log (Passcode = 011)	No / Yes		
Firmware Version	x.xx				

DMX SETUP

DMX-512: DMX is short for Digital Multiplex. This is a universal protocol used as a form of communication between intelligent fixtures and controllers. A DMX controller sends DMX data instructions from the controller to the fixture. DMX data is sent as serial data that travels from fixture to fixture via the DATA “IN” and DATA “OUT” XLR terminals located on all DMX fixtures (most controllers only have a DATA “OUT” terminal).

DMX Linking: DMX is a language allowing all makes and models of different manufacturers to be linked together and operate from a single controller, as long as all fixtures and the controller are DMX compliant. To ensure proper DMX data transmission, try to use the shortest cable path possible when using several DMX fixtures. The order in which fixtures are connected in a DMX line does not influence the DMX addressing. For example, a fixture assigned a DMX address of 1 may be placed anywhere in a DMX line: at the beginning, at the end, or anywhere in the middle. When a fixture is assigned a DMX address of 1, the DMX controller knows to send DATA assigned to address 1 to that unit, no matter where it is located in the DMX chain.

Data Cable (DMX Cable) Requirements (For DMX Operation): The Jolt Panel FX can be controlled via DMX-512 protocol, and features multiple DMX channel modes. Your unit and your DMX controller require a 5-pin XLR connector for data input and data output. If you are making your own cables, be sure to use standard 110-120 Ohm shielded cable (This cable may be purchased at almost all pro lighting stores). Your cables should be made with a male XLR connector at one end and a female XLR connector on the other. Also remember that DMX cable must be daisy chained and cannot be split.

Special Note: Line Termination. When longer runs of cable are used, you may need to use a terminator on the last unit to avoid erratic behavior. A terminator is a 110-120 ohm 1/4 watt resistor which is connected between pins 2 and 3 of a male XLR connector (DATA + and DATA -). This unit is inserted in the female XLR connector of the last unit in your daisy chain to terminate the line. Using a cable terminator (ADJ part number Z-DMX/T) will decrease the chances of erratic behavior.

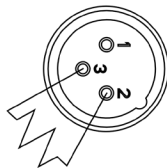
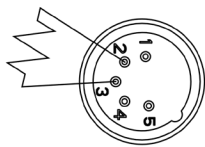

A DMX512 terminator reduces signal errors, avoiding most signal reflection interference. Connect PIN 2 (DMX-) and PIN 3 (DMX+) of the last fixture in series with a 120 Ohm, 1/4 W Resistor to terminate the DMX512.

DMX SETUP

DMX ADDRESSING

All fixtures should be given a DMX starting address when operating with a DMX controller, in order to ensure that the correct fixture responds to the correct control signal. This digital starting address is the channel number from which the fixture starts to “listen” to the digital control signal sent out from the DMX controller. The assignment of this starting DMX address is achieved by setting the correct DMX address on the digital control display on the fixture.

You can set the same starting address for all fixtures or a group of fixtures, or set different addresses for each individual fixture. Setting all fixtures to the same DMX address will cause all fixtures to react in the same way. In this case, please note that changing the settings of one channel will affect all the fixtures simultaneously.

If you set each fixture to a different DMX address, each unit will “listen” starting at the channel number you have set, based on the quantity of DMX channels of each fixture. That means changing the settings of one channel will only affect the selected fixture.

As an example, when operating this device in 6 channel mode, you should set the starting DMX address of the first unit to 1, the second unit to 7 (1 + 6), the third unit to 13 (1 + 6 + 6), and so on. (See the chart below for more details.)

Channel Mode	Unit 1 Address	Unit 2 Address	Unit 3 Address	Unit 4 Address
6 Channels	1	7	13	19
9 Channels	1	10	19	28
13 Channels	1	14	27	40
18 Channels	1	19	37	55
36 Channels	1	37	73	109
41 Channels	1	42	83	124
126 Channels	1	127	253	379
141 Channels	1	142	283	424

DMX TRAITS

CHANNEL								DMX VALUES	FUNCTION
6 CH	9 CH	13 CH	18 CH	36 CH	41 CH	126 CH	141 CH		
1	1	1	1					000 - 255	Outer Red , 0% to 100%
2	2	2	2					000 - 255	Outer Green , 0% to 100%
3	3	3	3					000 - 255	Outer Blue , 0% to 100%
4	4	4						000 - 255	Inner White , 0% to 100%
				30	33			000 - 255	Inner White Group 1
				31	34			000 - 255	Inner White Group 2
5	5	6						000 - 255	Dimmer , 0% to 100%
6	6	7						000 - 255	Dimmer Fine , 0% to 100%
			5	25	26		122	000 - 255	Outer Dimmer , 0% to 100%
			6	26	27		123	000 - 255	Outer Dimmer Fine , 0% to 100%
									Strobe Effect
								000 - 002	Open
								003 - 005	Strobe
								006 - 050	Ramp up
								051 - 100	Ramp down
								101 - 150	Ramp up-down
								151 - 200	Lightning
								201 - 255	Random
	8	9						000 - 255	Strobe Rate , slow to fast
	9	10						000 - 255	Strobe Duration , slow to fast
		5	4		25		121	000 - 255	Outer Color Macros
									Outer Strobe Effect
								000 - 002	Open
								003 - 005	Strobe
								006 - 050	Ramp up
								051 - 100	Ramp down
								101 - 150	Ramp up-down
								151 - 200	Lightning
								201 - 255	Random
			8	28	29		125	000 - 255	Outer Strobe Rate , slow to fast
			9	29	30		126	000 - 255	Outer Strobe Duration , slow to fast

CONTINUED ON NEXT PAGE

DMX TRAITS

CHANNEL								DMX VALUES	FUNCTION
6 CH	9 CH	13 CH	18 CH	36 CH	41 CH	126 CH	141 CH		
									<i>Outer Program Macro</i>
								000 - 005	No function
								006 - 015	Macro1
								016 - 025	Macro2
								026 - 035	Macro3
								036 - 045	Macro4
								046 - 055	Macro5
								056 - 065	Macro6
								066 - 075	Macro7
								076 - 085	Macro8
								086 - 095	Macro9
								096 - 105	Macro10
								106 - 115	Macro11
		11	10		31		127	116 - 125	Macro12
								126 - 135	Macro13
								136 - 145	Macro14
								146 - 155	Macro15
								156 - 165	Macro16
								166 - 175	Macro17
								176 - 185	Macro18
								186 - 195	Macro19
								196 - 205	Macro20
								206 - 215	Macro21
								216 - 225	Macro22
								226 - 235	Macro23
								236 - 245	Macro24
								246 - 255	Macro25
			11		32		128	000 - 255	<i>Outer Program Macro Speed</i>
			12	32	35		135	000 - 255	<i>Inner Dimmer, 0% to 100%</i>
			13	33	36		136	000 - 255	<i>Inner Dimmer Fine, 0% to 100%</i>

CONTINUED ON NEXT PAGE

DMX TRAITS

CHANNEL								DMX VALUES	FUNCTION
6 CH	9 CH	13 CH	18 CH	36 CH	41 CH	126 CH	141 CH		
			14	34	37		137		<i>Inner Strobe Effect</i>
								000 - 002	Open
								003 - 005	Strobe
								006 - 050	Ramp up
								051 - 100	Ramp down
								101 - 150	Ramp up-down
								151 - 200	Lightning
								201 - 255	Random
			15	35	38		138	000 - 255	<i>Inner Strobe Rate</i> , slow to fast
			16	36	39		139	000 - 255	<i>Inner Strobe Duration</i> , slow to fast
			12	17	40		140		<i>Inner Program Macro</i>
								000 - 005	No function
								006 - 033	Macro1
								034 - 060	Macro2
								061 - 088	Macro3
								089 - 116	Macro4
								117 - 144	Macro5
								145 - 172	Macro6
								173 - 200	Macro7
								201 - 228	Macro8
								229 - 255	Macro9
			18		41		141	000 - 255	<i>Inner Program Macro Speed</i>
		13						000 - 255	<i>In/Out Program Macro Speed</i> , slow to fast
				1	1	1	1	000 - 255	<i>Red 1</i>
				2	2	2	2	000 - 255	<i>Green 1</i>
				3	3	3	3	000 - 255	<i>Blue 1</i>
				4	4	4	4	000 - 255	<i>Red 2</i>
				5	5	5	5	000 - 255	<i>Green 2</i>
				6	6	6	6	000 - 255	<i>Blue 2</i>
				7	7	7	7	000 - 255	<i>Red 3</i>
				8	8	8	8	000 - 255	<i>Green 3</i>
				9	9	9	9	000 - 255	<i>Blue 3</i>
				10	10	10	10	000 - 255	<i>Red 4</i>
				11	11	11	11	000 - 255	<i>Green 4</i>
				12	12	12	12	000 - 255	<i>Blue 4</i>

CONTINUED ON NEXT PAGE

DMX TRAITS

CHANNEL								DMX VALUES	FUNCTION
6 CH	9 CH	13 CH	18 CH	36 CH	41 CH	126 CH	141 CH		
				13	13	13	13	000 - 255	<i>Red 5</i>
				14	14	14	14	000 - 255	<i>Green 5</i>
				15	15	15	15	000 - 255	<i>Blue 5</i>
				16	16	16	16	000 - 255	<i>Red 6</i>
				17	17	17	17	000 - 255	<i>Green 6</i>
				18	18	18	18	000 - 255	<i>Blue 6</i>
				19	19	19	19	000 - 255	<i>Red 7</i>
				20	20	20	20	000 - 255	<i>Green 7</i>
				21	21	21	21	000 - 255	<i>Blue 7</i>
				22	22	22	22	000 - 255	<i>Red 8</i>
				23	23	23	23	000 - 255	<i>Green 8</i>
				24	24	24	24	000 - 255	<i>Blue 8</i>
						25	25	000 - 255	<i>Red 9</i>
						26	26	000 - 255	<i>Green 9</i>
						27	27	000 - 255	<i>Blue 9</i>
						28	28	000 - 255	<i>Red 10</i>
						29	29	000 - 255	<i>Green 10</i>
						30	30	000 - 255	<i>Blue 10</i>
						31	31	000 - 255	<i>Red 11</i>
						32	32	000 - 255	<i>Green 11</i>
						33	33	000 - 255	<i>Blue 11</i>
						34	34	000 - 255	<i>Red 12</i>
						35	35	000 - 255	<i>Green 12</i>
						36	36	000 - 255	<i>Blue 12</i>
						37	37	000 - 255	<i>Red 13</i>
						38	38	000 - 255	<i>Green 13</i>
						39	39	000 - 255	<i>Blue 13</i>
						40	40	000 - 255	<i>Red 14</i>
						41	41	000 - 255	<i>Green 14</i>
						42	42	000 - 255	<i>Blue 14</i>
						43	43	000 - 255	<i>Red 15</i>
						44	44	000 - 255	<i>Green 15</i>
						45	45	000 - 255	<i>Blue 15</i>
						46	46	000 - 255	<i>Red 16</i>
						47	47	000 - 255	<i>Green 16</i>

CONTINUED ON NEXT PAGE

DMX TRAITS

CHANNEL								DMX VALUES	FUNCTION
6 CH	9 CH	13 CH	18 CH	36 CH	41 CH	126 CH	141 CH		
						48	48	000 - 255	<i>Blue 16</i>
						49	49	000 - 255	<i>Red 17</i>
						50	50	000 - 255	<i>Green 17</i>
						51	51	000 - 255	<i>Blue 17</i>
						52	52	000 - 255	<i>Red 18</i>
						53	53	000 - 255	<i>Green 18</i>
						54	54	000 - 255	<i>Blue 18</i>
						55	55	000 - 255	<i>Red 19</i>
						56	56	000 - 255	<i>Green 19</i>
						57	57	000 - 255	<i>Blue 19</i>
						58	58	000 - 255	<i>Red 20</i>
						59	59	000 - 255	<i>Green 20</i>
						60	60	000 - 255	<i>Blue 20</i>
						61	61	000 - 255	<i>Red 21</i>
						62	62	000 - 255	<i>Green 21</i>
						63	63	000 - 255	<i>Blue 21</i>
						64	64	000 - 255	<i>Red 22</i>
						65	65	000 - 255	<i>Green 22</i>
						66	66	000 - 255	<i>Blue 22</i>
						67	67	000 - 255	<i>Red 23</i>
						68	68	000 - 255	<i>Green 23</i>
						69	69	000 - 255	<i>Blue 23</i>
						70	70	000 - 255	<i>Red 24</i>
						71	71	000 - 255	<i>Green 24</i>
						72	72	000 - 255	<i>Blue 24</i>
						73	73	000 - 255	<i>Red 25</i>
						74	74	000 - 255	<i>Green 25</i>
						75	75	000 - 255	<i>Blue 25</i>
						76	76	000 - 255	<i>Red 26</i>
						77	77	000 - 255	<i>Green 26</i>
						78	78	000 - 255	<i>Blue 26</i>
						79	79	000 - 255	<i>Red 27</i>
						80	80	000 - 255	<i>Green 27</i>
						81	81	000 - 255	<i>Blue 27</i>
						82	82	000 - 255	<i>Red 28</i>

CONTINUED ON NEXT PAGE

DMX TRAITS

CHANNEL								DMX VALUES	FUNCTION
6 CH	9 CH	13 CH	18 CH	36 CH	41 CH	126 CH	141 CH		
						83	83	000 - 255	<i>Green 28</i>
						84	84	000 - 255	<i>Blue 28</i>
						85	85	000 - 255	<i>Red 29</i>
						86	86	000 - 255	<i>Green 29</i>
						87	87	000 - 255	<i>Blue 29</i>
						88	88	000 - 255	<i>Red 30</i>
						89	89	000 - 255	<i>Green 30</i>
						90	90	000 - 255	<i>Blue 30</i>
						91	91	000 - 255	<i>Red 31</i>
						92	92	000 - 255	<i>Green 31</i>
						93	93	000 - 255	<i>Blue 31</i>
						94	94	000 - 255	<i>Red 32</i>
						95	95	000 - 255	<i>Green 32</i>
						96	96	000 - 255	<i>Blue 32</i>
						97	97	000 - 255	<i>Red 33</i>
						98	98	000 - 255	<i>Green 33</i>
						99	99	000 - 255	<i>Blue 33</i>
						100	100	000 - 255	<i>Red 34</i>
						101	101	000 - 255	<i>Green 34</i>
						102	102	000 - 255	<i>Blue 34</i>
						103	103	000 - 255	<i>Red 35</i>
						104	104	000 - 255	<i>Green 35</i>
						105	105	000 - 255	<i>Blue 35</i>
						106	106	000 - 255	<i>Red 36</i>
						107	107	000 - 255	<i>Green 36</i>
						108	108	000 - 255	<i>Blue 36</i>
						109	109	000 - 255	<i>Red 37</i>
						110	110	000 - 255	<i>Green 37</i>
						111	111	000 - 255	<i>Blue 37</i>
						112	112	000 - 255	<i>Red 38</i>
						113	113	000 - 255	<i>Green 38</i>
						114	114	000 - 255	<i>Blue 38</i>
						115	115	000 - 255	<i>Red 39</i>
						116	116	000 - 255	<i>Green 39</i>
						117	117	000 - 255	<i>Blue 39</i>

CONTINUED ON NEXT PAGE

DMX TRAITS

CHANNEL								DMX VALUES	FUNCTION
6 CH	9 CH	13 CH	18 CH	36 CH	41 CH	126 CH	141 CH		
						118	118	000 - 255	<i>Red 40</i>
						119	119	000 - 255	<i>Green 40</i>
						120	120	000 - 255	<i>Blue 40</i>
						121	129	000 - 255	<i>White 1</i>
						122	130	000 - 255	<i>White 2</i>
						123	131	000 - 255	<i>White 3</i>
						124	132	000 - 255	<i>White 4</i>
						125	133	000 - 255	<i>White 5</i>
						126	134	000 - 255	<i>White 6</i>

LED PIXEL ZONES

6 / 9 / 13 / 18 CHANNEL MODE

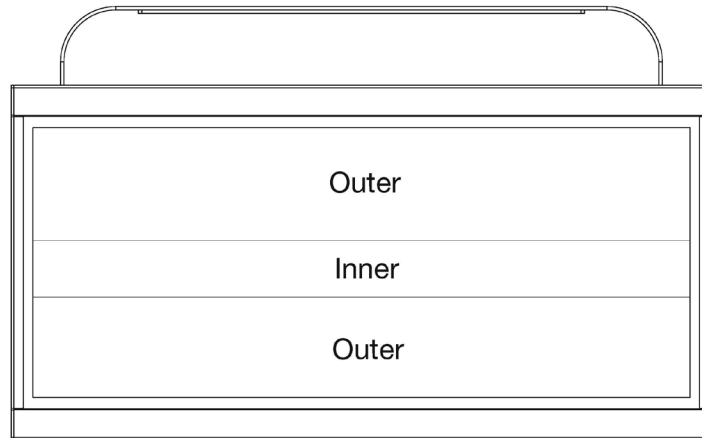

36 / 41 CHANNEL MODE

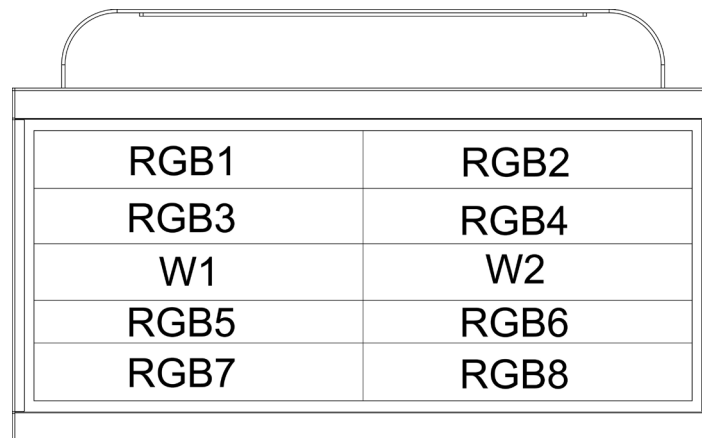

126 / 141 CHANNEL MODE

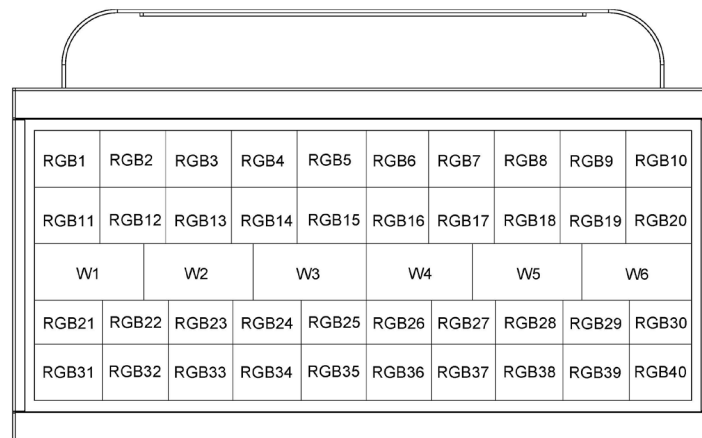

DIMMER MODES AND CURVES

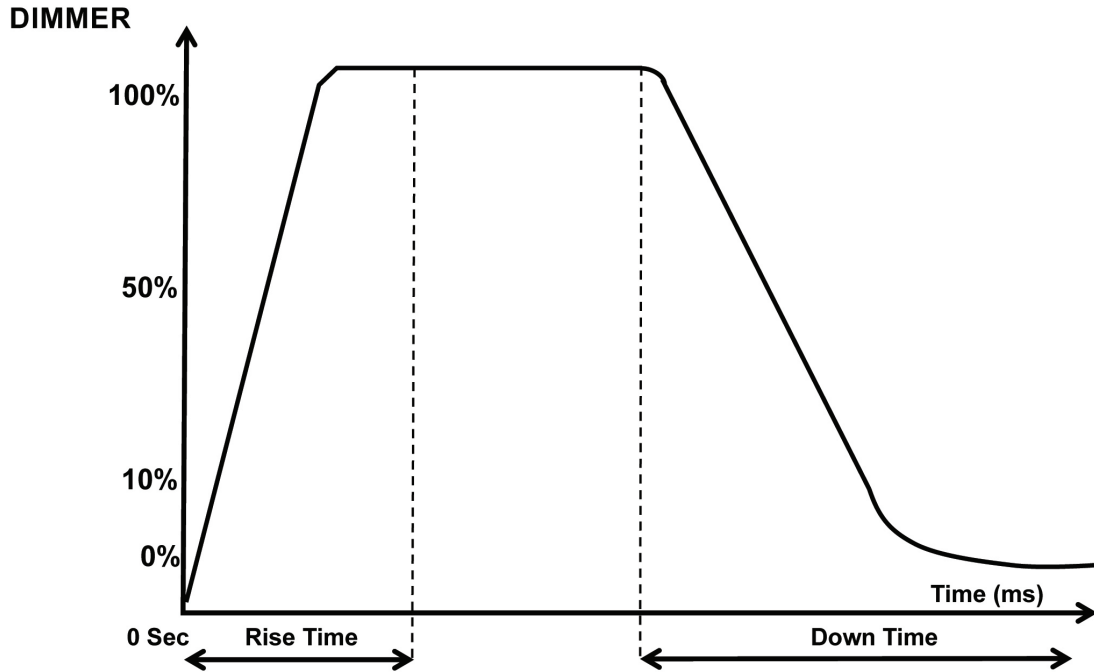

Dimming Curve Ramp Effect	0 sec Fade Time		1 sec Fade Time	
	Rise Time (ms)	Down Time (ms)	Rise Time (ms)	Down Time (ms)
Standard (default)	0	0	0	0
Stage	780	1100	1540	1660
TV	1180	1520	1860	1940
Architectural	1380	1730	2040	2120
Theatre	1580	1940	2230	2280
Stage 2	0	1100	0	1660

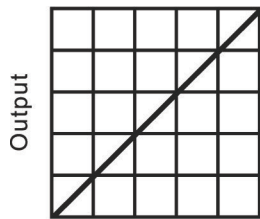

DMX %

Linear

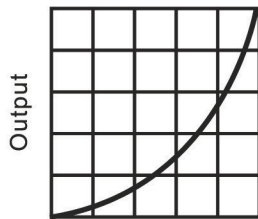

DMX %

Square

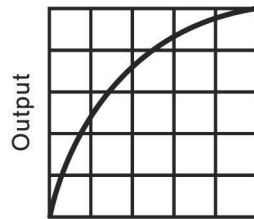

DMX %

Inverse Square

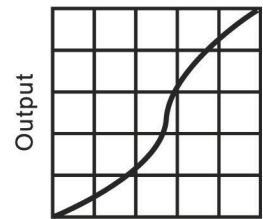

DMX %

S Curve

DAISY CHAIN POWER LINKING

These units have the capability to be daisy chained together via the power in/out ports. **The maximum number of units that can be linked together in this manner is as follows:**

- **4 units maximum when running on 100V power.**
- **9 units maximum when running on 230V power.**

DO NOT EXCEED THE NUMBER OF UNITS LISTED ABOVE.

DO NOT MIX MAKE AND MODEL TYPES WHEN DAISY CHAINING! All units that are connected in this manner must be of the same make and model type.

CLEANING AND MAINTENANCE

DISCONNECT POWER BEFORE PERFORMING ANY MAINTENANCE!

CLEANING

Frequent cleaning is recommended to ensure proper function, optimized light output, and an extended life. The frequency of cleaning depends on the environment in which the fixture operates: damp, smoky, or particularly dirty environments can cause greater accumulation of dirt on the fixture's optics. Clean the external lens surface periodically with a soft cloth to avoid dirt/debris accumulation.

NEVER use alcohol, solvents, or ammonia-based cleaners.

MAINTENANCE

Regular inspections are recommended to ensure proper function and extended life. There are no user serviceable parts inside this fixture. Please refer all other service issues to an authorized ADJ service technician. Should you need any spare parts, please order genuine parts from your local ADJ dealer.

Please refer to the following points during routine inspections:

- A detailed electrical check by an approved electrical engineer every three months, to make sure the circuit contacts are in good condition and prevent overheating.
- Be sure all screws and fasteners are securely tightened at all times. Loose screws may fall out during normal operation, resulting in damage or injury as larger parts could fall.
- Check for any deformations on the housing, color lenses, rigging hardware, and rigging points (ceiling, suspension, trussing). Deformations in the housing could allow for dust or liquids to enter into the fixture. Damaged rigging points or unsecured rigging could cause fixture to fall and seriously injure a person(s).
- Electric power supply cables must not show any damage, material fatigue, or sediments.

NEVER remove the ground prong from the power cable.

SOFTWARE UPDATE INSTRUCTIONS

ONLY QUALIFIED TECHNICIANS SHOULD PERFORM THIS FUNCTION! NOTE ALL MENU SETTINGS BEFORE UPDATING SOFTWARE!

FIXTURE SOFTWARE CANNOT BE DOWNGRADED!

DOWNLOAD FIXTURE SOFTWARE TO PC ONLY! (NO MAC SUPPORT)

PLEASE CONTACT ADJ CUSTOMER SERVICE FOR FURTHER INFORMATION

1. Contact ADJ customer service to obtain the updated software. Download the software to a USB flash drive. In order to minimize the risk of downloading the incorrect software to your device, make sure that the desired update files are the only files present on the USB flash drive. It is also recommended to use a flash drive that is Fat32 format and less than 32GB.
2. Disconnect any DMX connections from your device, then insert the USB flash drive into the service port on your device.
3. Use the display screen and control panel to navigate to Personality > Service > Update Software > Yes. See the **System Menu** section of this manual for detailed instructions. Enter the passcode when prompted.
4. Select the file with the name "V00" and allow the unit to update until the readout has gone from 0% to 100%.
5. Repeat the process, this time select the "Vx.xx" software file that you would like to install, where x.xx represents the version number of the updated software.

DIMENSIONAL DRAWINGS

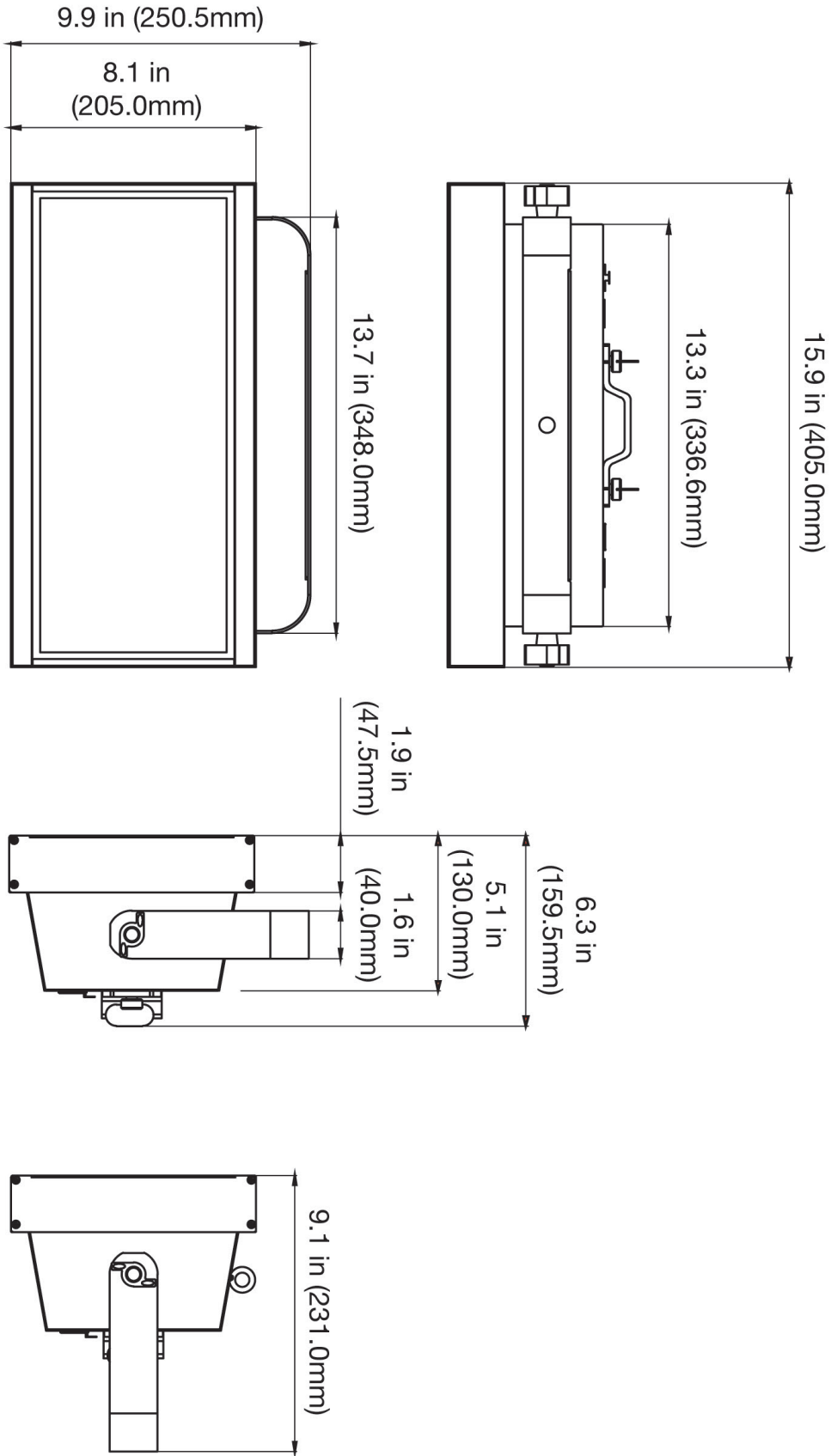

Dimensions are not drawn to scale.

SPECIFICATIONS

LIGHT SOURCE:

- 800 RGB SMD LEDs + 48 Cool White SMD LEDs
- RGB LEDs: 121 Degree Beam Angle
- Cool White LEDs: 89 Degree Beam Angle
- Color Temperature: Red: 620-630nm. Green: 515-525nm. Blue: 460-470nm. / Cool White: 6500-7000K

- 50,000 Hour Average LED Life

FEATURES:

- 40 x RGB LED zones
- 6 x Cool White LED zones
- 25 built-in RGB LED Program Macros

- 9 built-in Cool White LED Program Macros

CONTROL:

- Control Protocol: DMX
- 8 DMX Modes: 6, 9, 13, 18, 36, 41, 126, and 141 channels
- 0-100% Smooth Dimming
- Strobe, shutter & pulse control
- Max Strobe Rate 25Hz. Min Strobe Rate: 0.35Hz.

- Display: LCD display with 4-button touch menu

CONNECTIONS:

- Data: 5-pin DMX In/Out
- 180 degree mounting bracket system
- Ready for Omega Bracket (Sold Separately)

- Power locking power in/out

ELECTRICAL:

- 100-240V 50Hz/60Hz (Auto Sensing)

- Max Power Consumption: 300W (1.4A@230V~50Hz)

DIMENSIONS / WEIGHT:

- Length: 159.5mm
- Width: 405.0mm
- Height: 250.5mm
- Weight: 6kg

Specifications and manual are subject to change and improvement without prior written notice.

