

HF101

PRO HF HORN

DESCRIPTION

1-inch Throat Adaptor. 90° x 70° Constant Directivity Coverage. Loading down to 1000 Hz. Aluminum Body. Perfectly Controlled Dispersion.



FEATURES

- 1-inch Throat Adaptor
- 90° x 70° Constant Directivity Coverage
- Loading down to 1000 Hz
- Aluminum Body
- Perfectly Controlled Dispersion

TECHNICAL SPECIFICATIONS**General specifications**

Throat Diameter:	25-36 mm / 1.0-1.4 inch
Horizontal coverage angle:	90°
Vertical coverage angle:	70°
Cut-off Frequency:	1000 Hz
Material:	Aluminium

Mounting informations

Overall height:	180 mm / 7.09 inches
Overall width:	180 mm / 7.09 inches
Overall depth:	106 mm / 4.17 inches
Baffle Cut-out height:	150 mm / 5.91 inches
Baffle Cut-out width:	150 mm / 5.91 inches
Mounting:	4 x 8 mm holes, interaxes 76 mm

Standard compliance

CE marking:	Yes
-------------	-----

Size

Height:	117 mm / 4.61 inches
Diameter:	180 mm / 7.09 inches
Weight:	0.16 kg / 0.35 lbs

Shipping informations

Package Height:	130 mm / 5.12 inches
Package Width:	205 mm / 8.07 inches
Package Depth:	200 mm / 7.87 inches
Package Weight:	0.83 kg / 1.83 lbs

PART NUMBER

- **13133048**

HF101

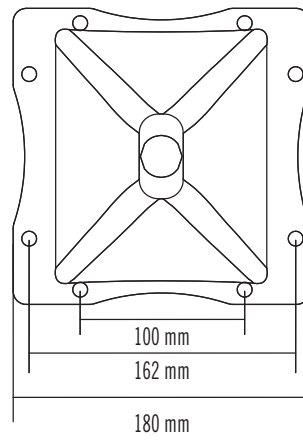
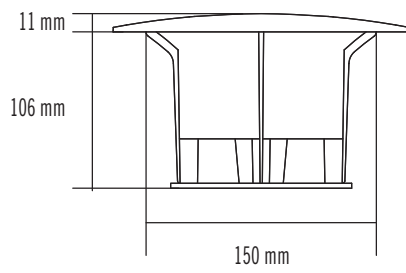

Response 1W/1m

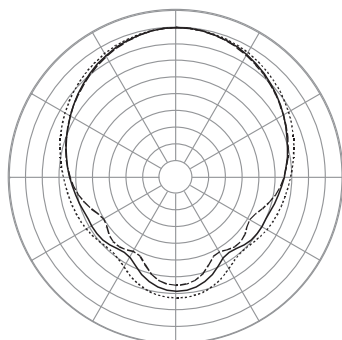
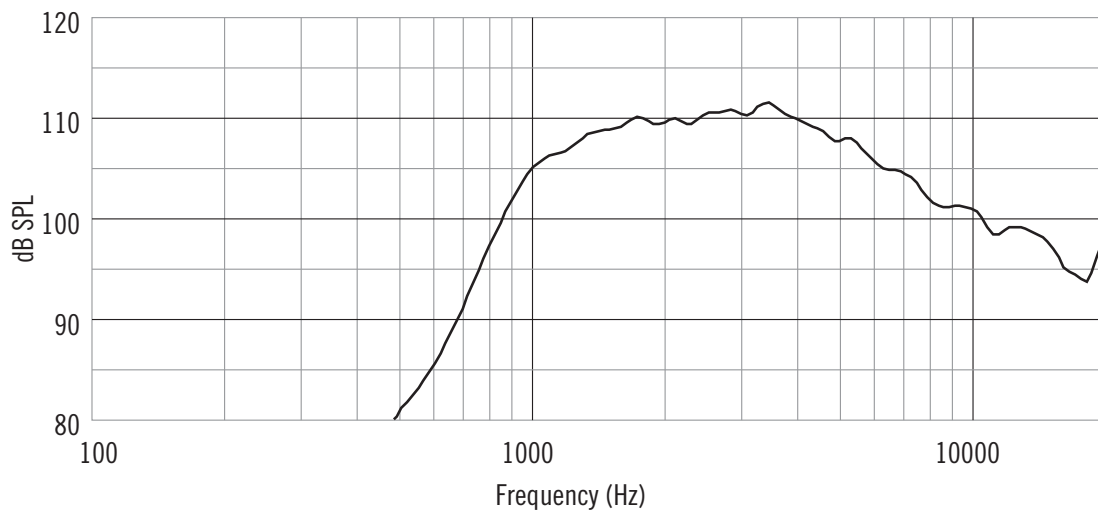

Horizontal 2000 Hz
1/3 Octave Polars

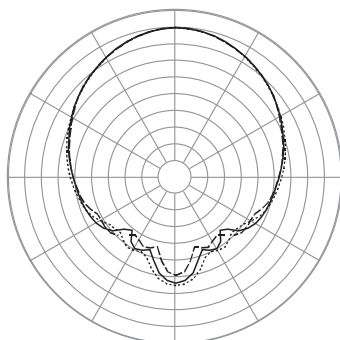

Horizontal 4000 Hz
1/3 Octave Polars

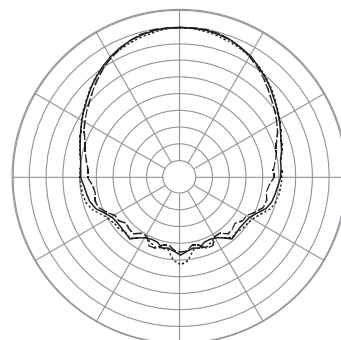

Horizontal 8000 Hz
1/3 Octave Polars

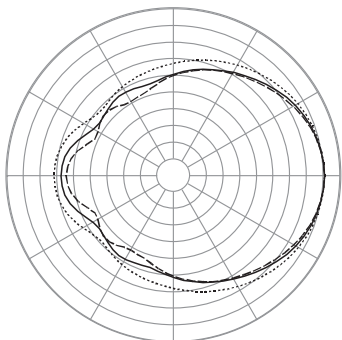

Vertical 2000 Hz
1/3 Octave Polars

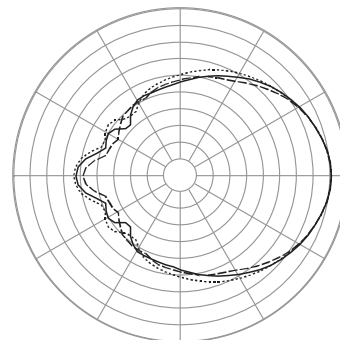

Vertical 4000 Hz
1/3 Octave Polars

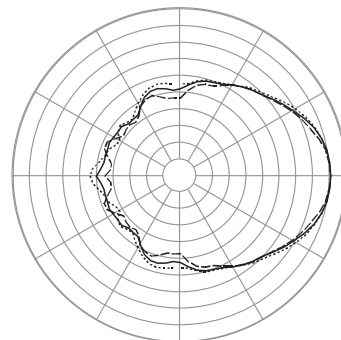

Vertical 8000 Hz
1/3 Octave Polars