

NX 12-SMA

ACTIVE COAXIAL STAGE MONITOR



MAIN APPLICATIONS

- Main vocal stage monitor
- High-output guitar or keyboard monitor
- Main PA in small venues
- Portable and installed audio-visual systems

MAIN FEATURES

- 700 Watt digital bi-amplification
- 129 dB max spl
- Wide dispersion 60° x 60° constant directivity horn
- 12" High power neodymium woofer, 2.5" voice coil
- 1,7" kapton dome, 1" exit, neodymium high frequency driver
- DSP processing, boost eq, soft limiter and protection
- Xlr/jack input, xlr signal output

DESCRIPTION

NX Series maximum flexibility philosophy has been maintained for NX12-SMA; it is possible, in fact, to use it as a portable PA system, thanks to the rugged powder coated steel pole mount installed on the side. The newly designed 12" +1" coaxial neodymium transducers guarantee an outstanding audio quality and definition as well as an extremely lightweight of the final system.

The advantages of the coaxial transducers are the complete absence of feedback and, thanks to the coherent single spherical wave front with a perfect dispersion control, a perfect listening in every position.

The design is powered from a large sized single neodymium ring magnet that provides an extremely high flux density and BL factor.

The new hyper-vented aluminium basket and magnetic assembly design provide an excellent heat dissipation and lower power compression.

Special air-forced ventilations are provided for voice coil, magnet assembly and basket.

A 2,5" voice coil combined a strength fibreglass former and aluminium wire drives the mid-bass cone with high efficiency and a good extension. The 1,7" dome compression driver, loaded to a 60° conical waveguide, provides a clear vocal output and a perfect high frequency extension.

The NX Coaxial Stage Monitors are provided with brand new digital amplifiers with powerful DSP processing. The NX 12-SMA is equipped with a 700 W amplifier, 500 W feed the low frequencies and 200 W are used for the high frequencies.

In order to control the response of the speakers in such different applications, RCF has incorporated two special Equalization Modes: Floor, for stage monitoring and Free Field, for the use of the speakers as a stand-alone PA system.

The input board is fully equipped in order to configure the stage monitors for any stage situation with XLR Input and Output Link, Jack Input, Volume, Input Sensitivity Switch, Free Field – Floor Switch, Status LEDs, Powercon AC Input and Output Link.

Cabinets are made in Baltic Birch plywood, finished with an extremely resistant paint for an extensive use on the road. An ergonomic side handle, integrated with the input panel, is provided for an easier transport.

ACOUSTICAL SPECIFICATIONS

Frequency response:	50 Hz- 20 KHz
Max SPL:	129 dB
Horizontal coverage angle:	60°
Vertical coverage angle:	60°
Compression driver:	1" neo, 1.7" voice coil
Woofer:	12" neo, 2.5" voice coil

INPUT SECTION

Input signal (Impedance):	bal/unbal
Input/Output connector:	XLR, Jack / XLR
Input sensitivity:	+4 dBu

PROCESSOR SECTION

Crossover frequencies:	1700 Hz
Protections:	RMS limiter, HF
Sensitivity control:	-
Limiter:	soft limiter
High pass:	-
Controls:	freefield, floor

AMPLIFIER

Power supply:	switching 700 Watt
High frequencies:	D / 200 Watt
Low frequencies:	D / 500 Watt
Cooling:	convection
Connection:	powercon Input / powercon Output

PHYSICAL

Height:	324 mm (12.7")
Width:	550 mm (21.6")
Depth:	417 mm (16.4")
Weight:	16.5 kg (36.3 lbs)
Cabinet:	baltic birch plywood
Hardware:	-
Handles:	1 side aluminum handle
Pole mount cap:	yes
Colour:	Black



NX 12-SMA

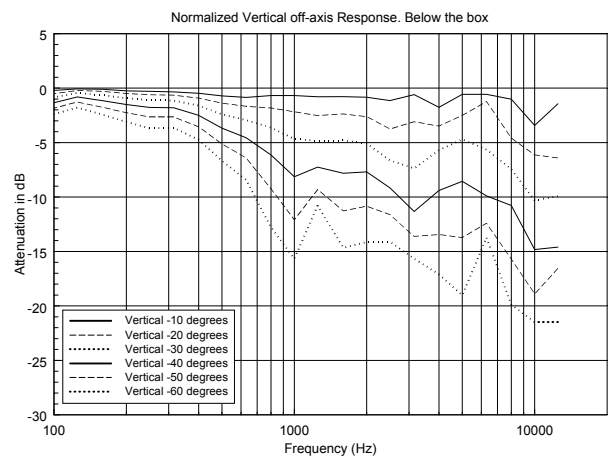
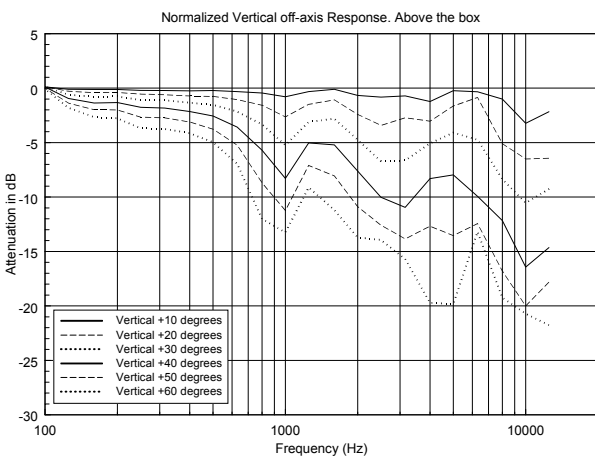
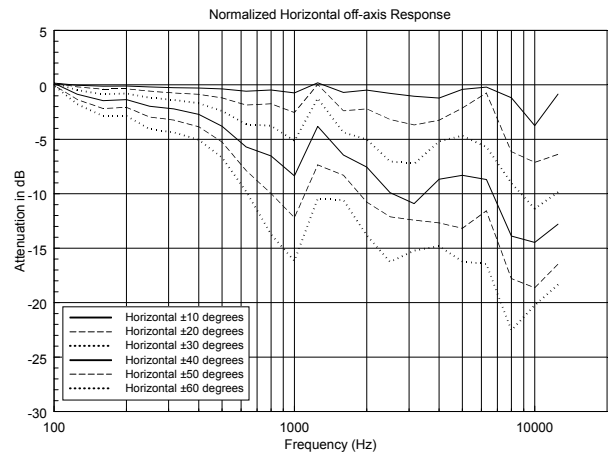
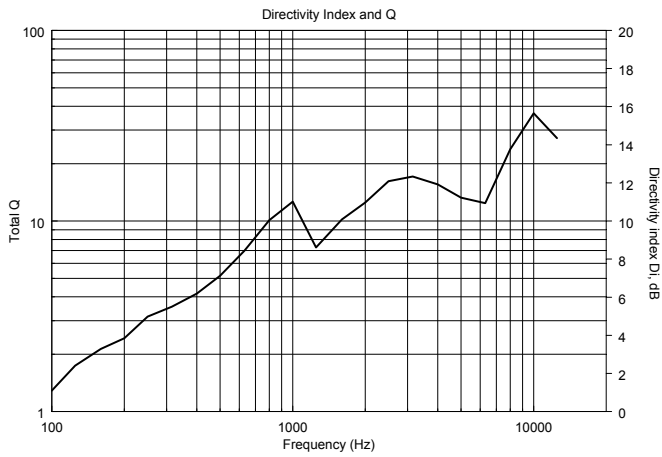
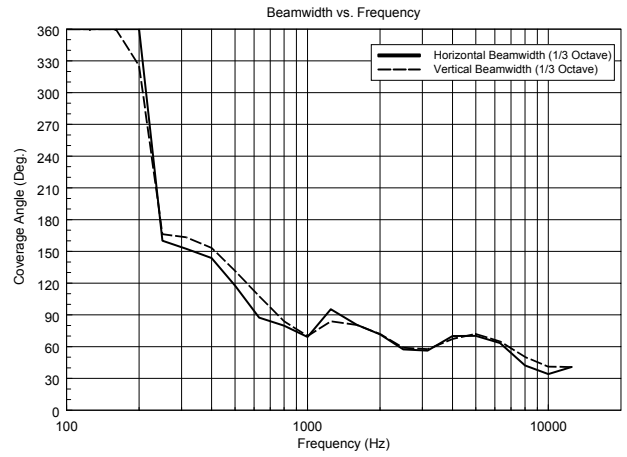
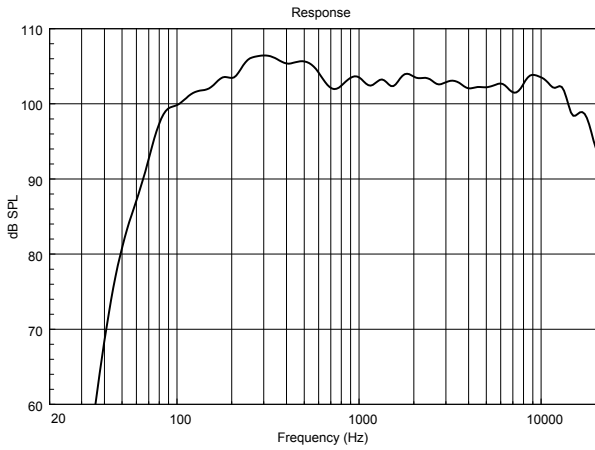

NX 12-SMA

HORIZONTAL 1/3 POLAR PLOT

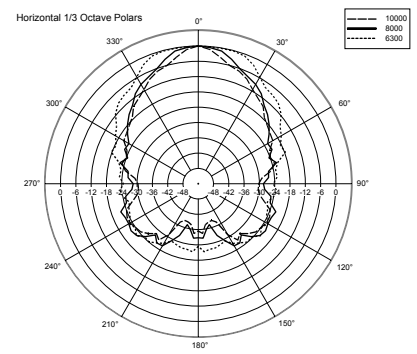
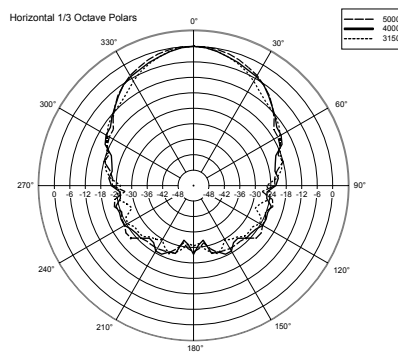
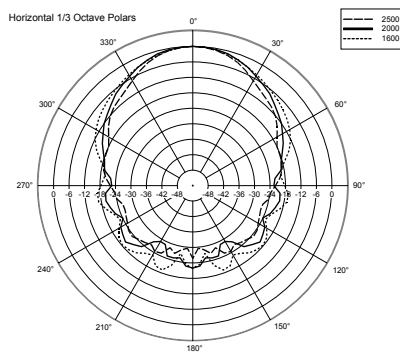
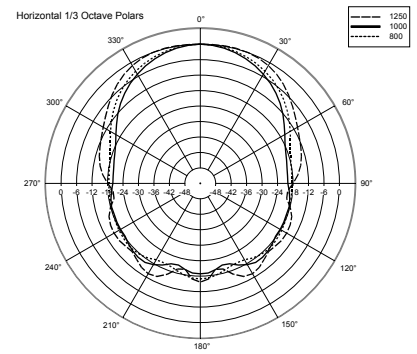
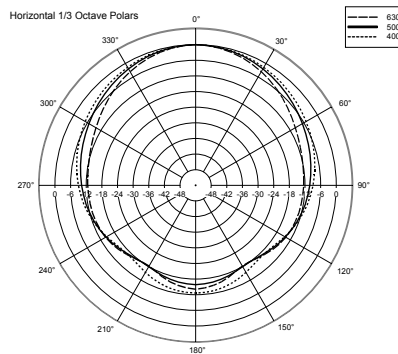
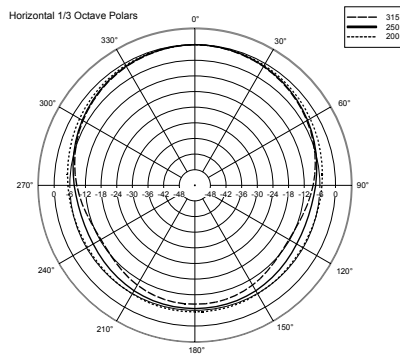

VERTICAL 1/3 POLAR PLOT

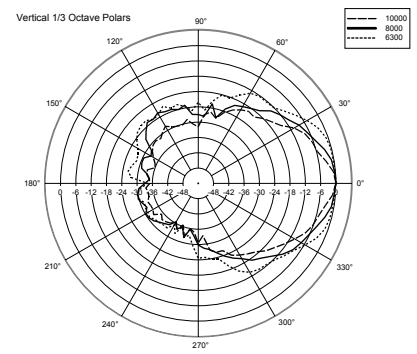
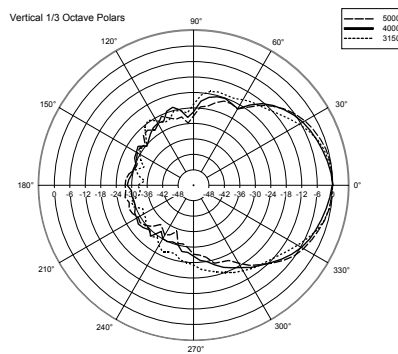
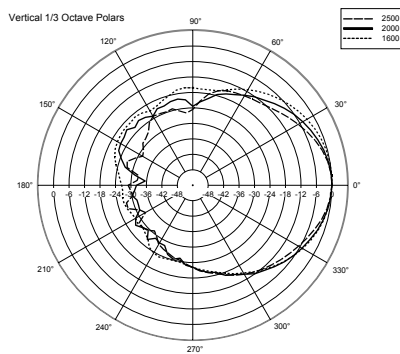
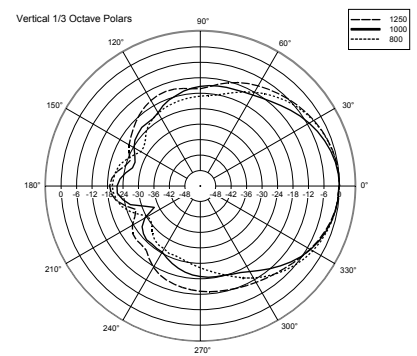
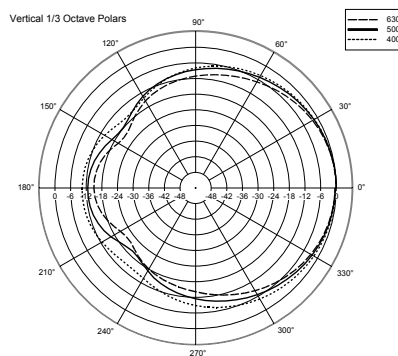
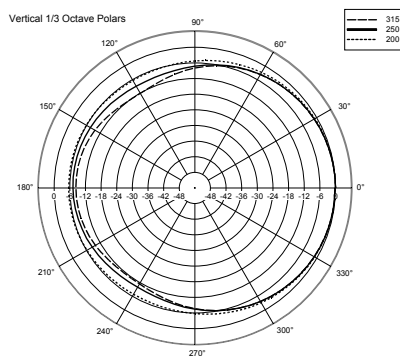

NX 12-SMA

PART NUMBERS

13000235 - 230VOLT

13000236 - 115 VOLT

DIMENSIONS (All data are in mm)

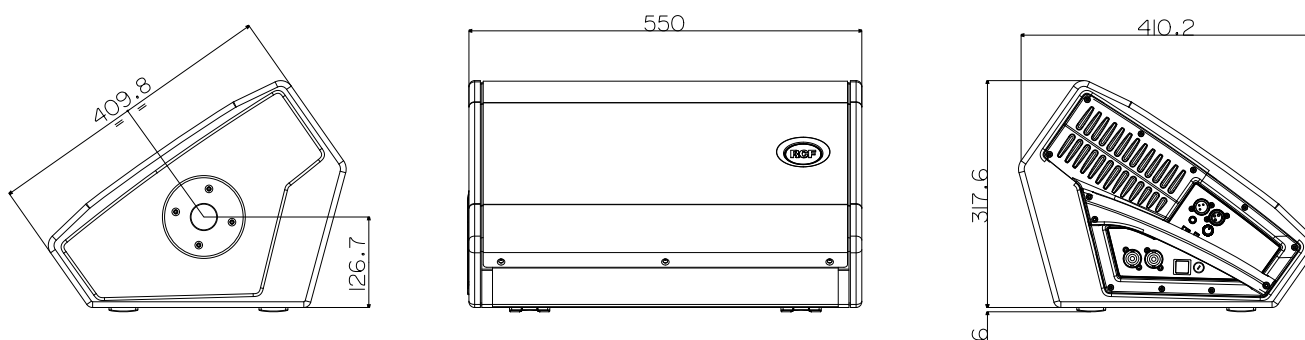

ACCESSORIES

AC PMA	Speaker pole mount.
AC PRO-FS	Steel speaker floor stand with folding base and telescopic rod. Tube diameter 35mm. Load capacity up to 50kg.
AC PRO-LF	Steel professional adapter sleeve for loudspeaker stands. Integrated expanding mandrel system which provides a tight and firm fit for the speaker. The moveable plastic splints separate the speaker from the stand creating a vibration-free connection.
AC PRO-PM	Steel pole mount accessory for a satellite loudspeaker on a subwoofer. Both ends of the pole mount are fitted with an expanding mandrel system for a tight and vibration-free fit for the base and satellite speakers.
AC S140	Aluminum speaker floor stand with folding base and telescopic rod, Tube diameter 35mm.
AC S260	Steel speaker floor stand with folding base and telescopic rod, tube diameter 35mm.
COVER NX12-SMA	Protection cover for NX 12-SMA